



~~TOP SECRET C~~
NO.
Copy #



CORONA J
PERFORMANCE EVALUATION REPORT

MISSION 1030-1 and 1030-2

FTV 1622, J-29

17 MAY 1967

Approved:



Advanced Projects

Declassified and Released by the NRO

In Accordance with E. O. 12958

NOV 26 1997

on

Approved



~~TOP SECRET C~~



FOREWORD

This report details the performance of the payload system during the operational phase of the [REDACTED] Flight Test Vehicle 1622.

Lockheed Missiles and Space Company has the responsibility for evaluating payload performance under the Level of Effort and "J" System contracts.

This document is the final payload test and performance evaluation report for Missions 1030-1 and 1030-2 which was launched on 9 March 1966.

TABLE OF CONTENTS

	<u>Page</u>
FRONT MATTER	i
TABLE OF CONTENTS	ii
ABBREVIATIONS	iii
ILLUSTRATIONS	iv
INTRODUCTION	1
1 - SYSTEM PERFORMANCE	2
2 - PRE-FLIGHT SYSTEMS TEST	5
3 - FLIGHT OPERATIONS	14
4 - MISSION 1030-1 RECOVERY SYSTEM	26
5 - MISSION 1030-2 RECOVERY SYSTEM	28
6 - MASTER (FWD) PANORAMIC CAMERA	30
7 - SLAVE (AFT) PANORAMIC CAMERA	32
8 - PANORAMIC CAMERA EXPOSURE	33
9 - DIFFUSE DENSITY MEASUREMENTS	46
10 - PERFORMANCE MEASUREMENTS	50
11 - OBSERVED DATA	51
12 - MISSION 1030-1 STELLAR-INDEX CAMERA	52
13 - MISSION 1030-2 STELLAR-INDEX CAMERA	53
14 - VEHICLE ATTITUDE	54
15 - IMAGE SMEAR ANALYSIS	67
16 - RADIATION DOSAGE	81
17 - RELIABILITY	82
18 - SUMMARY DATA	86
A - APPENDIX	93

LIST OF TABLES

Table		Page
2-1	J-29 TASC Pan Cycle Rates	10-12
2-2	TASC Clock/System Time Correlation	13
3-1	Engineering Operations Cycle Rates	18
3-2	Abnormal V/h Delay Home Position	19
3-3	Clock/System Time Correlation	20
3-4	Mission Temperature Summary	21 - 22
4-1	Mission 1030-1 Recovery Sequence	27
5-1	Mission 1030-2 Recovery Sequence	29
9-1	Processing - Exposure Summary	49
15-1	Mission 1030 V/h Ratio and Resolution Limits	75
17-1	Estimated Reliability Summary	84-85
18-1	Mission Summary	87-88
18-2	Performance Summary	89-90
18-3	Exposure - Processing Summary	91-92
A-1	Mission 1030-1 FWD Camera Density Distribution	A-1 thru A-6
A-2	Mission 1030-1 AFT Camera Density Distribution	A-13 thru A-23
A-3	Mission 1030-2 FWD Camera Density Distribution	A-33 thru A-38
A-4	Mission 1030-2 AFT Camera Density Distribution	A-48 thru A-53

LIST OF ILLUSTRATIONS

Figure		<u>Page</u>
1-1	Mission 1030 Inboard Profile	4
2-1	Master Camera Pre-Flight Resolution	8
2-2	Slave Camera Pre-Flight Resolution	9
3-1 to 3-3	System Temperatures Predicted vs. Actual	23-25
8-1	Mission 1030-1 Solar Elevations	34
8-2	Mission 1030-1 Solar Azimuth	35
8-3	Mission 1030-2 Solar Elevations	36
8-4	Mission 1030-2 Solar Azimuth	37
8-5 to 8-12	Nominal Exposure Points	38-45
9-1	Mission 1030 Density Ranges	48
14-1 to 14-6	Mission 1030-1 Attitude Angle & Rate Error Distributions	55-60
14-7 to 14-12	Mission 1030-2 Attitude Angle & Rate Error Distributions	61-66
15-1 to 15-6	Mission 1030-1 V/h Error & Resolution Limits Distributions	69-74
15-7 to 15-12	Mission 1030-2 V/h Error & Resolution Limits Distribution	75-80
A-1 to A-12	Mission 1030-1 FWD Camera Density Distribution	A-7 thru A-17
A-13 to A-21	Mission 1030-1 AFT Camera Density Distribution	A-24 thru A-32
A-22 to A-30	Mission 1030-2 FWD Camera Density Distribution	A-39 thru A-47
A-31 to A-39	Mission 1030-2 AFT Camera Density Distribution	A-54 thru A-62

INTRODUCTION

This report presents the final performance evaluation of Missions 1030-1 and 1030-2 of the Corona Program. The purpose of this report is to define the performance characteristics of the J-29 payload system, to identify the source of in-flight anomalies.

The performance evaluation was jointly conducted by representatives of Lockheed Missiles and Space Company (LMSC) and ITEK at the facilities of NPIC and AFSPPF. The off-line evaluation using Corona engineering photography acquired over the United States was performed at the individual contractors plants.

The quantitative data used for this report is obtained from government organizations. The diffuse density data, and MTF/AIM resolution are produced by AFSPPF. The vehicle attitude error values, frame correlation times are made at NPIC who also supply the Processing Summary and MTF/AIM resolution reports published by [REDACTED]

Computer programs developed by A/P are utilized to calculate and plot the frequency distribution of the various contributors to image smear to permit analysis and correlation of the conditions of photography to the information content and quality of the acquired pictures. Computer analysis of the exposure, processing and illumination data provides the necessary data to analyze the exposure criteria selected for the mission.

SECTION 1

SYSTEM PERFORMANCE

A. MISSION OBJECTIVES

The payload section of Mission 1030, placed into orbit by Flight Test Vehicle #1622 and LV-2A booster #452, consisted of two panoramic cameras, two Stellar-Index cameras, two Mark 5A recovery capsules and a space structure to enclose the cameras and provide mounting surfaces for all equipments. Figure 1-1 presents an inboard profile of the J-29 payload system. This Corona "J" system is designed to acquire search and reconnaissance photography of selected areas of the earth from orbital altitudes. The planned mission was a 5 day Phase I and a 4 day Phase 2 with no deactivate.

B. MISSION DESCRIPTION

The payload was launched from Vandenberg Air Force Base (VAFB) at 2202:03 Z (1402:03 PST) on 9 March 1966. Ascent and injection were normal and the achieved orbit was within nominal tolerances. Tracking and command support was effected by the Air Force Satellite Control Facility consisting of tracking and command stations at [REDACTED] under central control of the Satellite Test Center at Sunnyvale, California. The actual mission consisted of 2 five day photo operations.

The comparison of the planned and actual orbit parameters is tabulated as follows:

ORBIT PARAMETERS

<u>Parameter</u>	<u>Orbit 1 Predicted</u>	<u>Orbit 42 Actuals</u>	<u>Orbit 120 Actuals</u>
Period (Min.)	90.7	90.6	90.5
Perigee (N. M.)	99.6	97.6	98.8
Apogee (N. M.)	235.5	234.6	230.0
Inclination (Deg.)	75.0	75.0	75.0
Perigee Latitude (Deg.N.)	19.2	24.25	37.5
Eccentricity	0.0188	0.01899	0.01821

C. PANORAMIC CAMERAS

The Master and Slave panoramic cameras operated throughout both missions with no significant problems. The cloud cover observed in the photography averaged 35% for the mission. The photographic quality was lower than the best missions due to atmospheric conditions.

D. STELLAR-INDEX CAMERAS

Stellar-Index cameras operated satisfactorily during both missions. Photography was of acceptable quality.

E. OTHER SUB-SYSTEMS

The clock, instrumentation and the PMU systems performance was satisfactory.

The command system performed satisfactorily except for the V/h delay stepper switch which occasionally failed to home in Position 1.

~~TOP SECRET C~~

NO.

SCHEMATIC DECKBOARD PROFILE - CORONA J SYSTEM

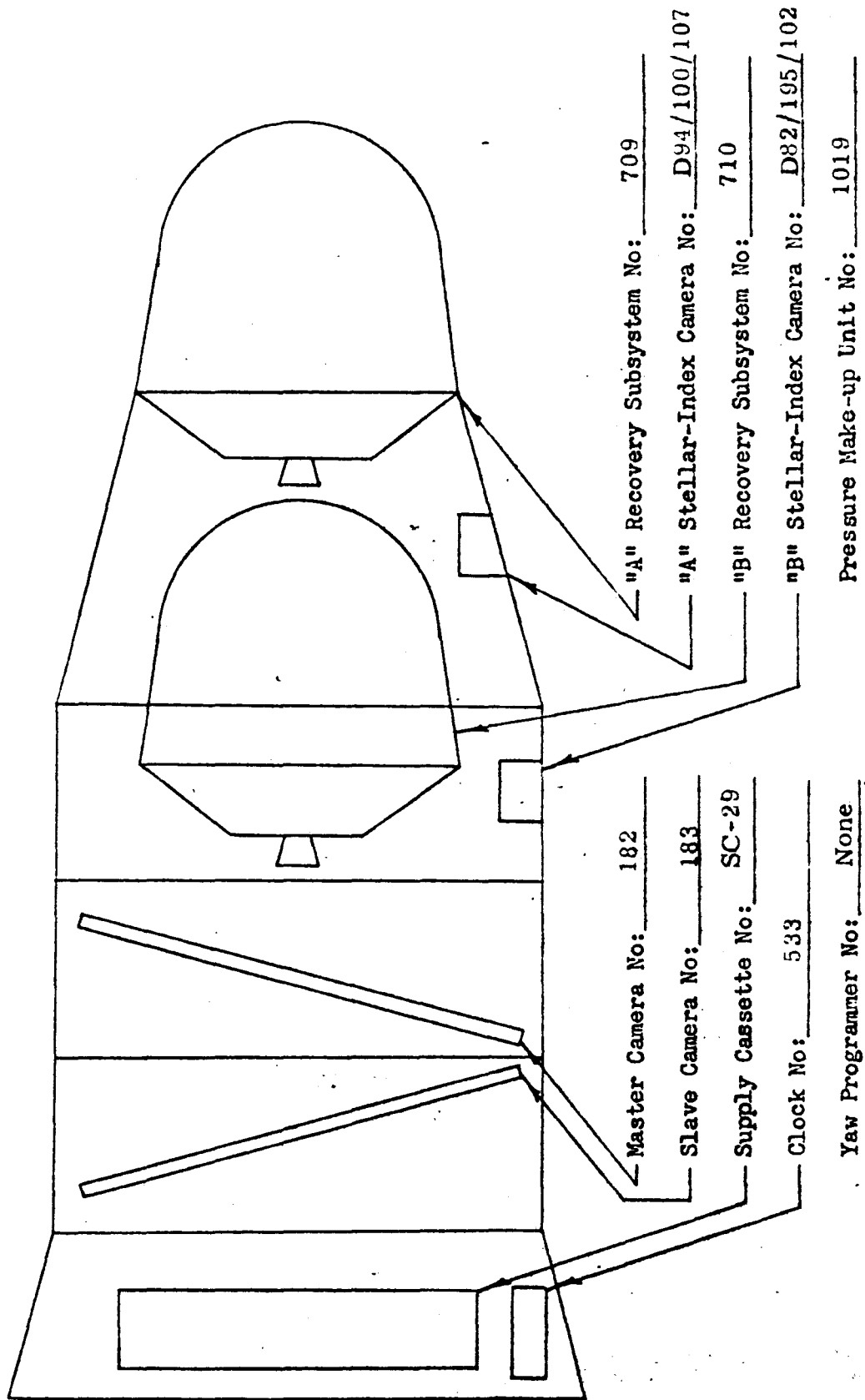

FIGURE 1-1

~~TOP SECRET C~~

SECTION 2

PRE-FLIGHT SYSTEMS TEST

A. ENVIRONMENTAL TESTING

1. Test Objective

As a standard procedure, the J payload systems are subjected to thermal/altitude environmental testing which simulates orbital environment. One of the purposes of this test is to demonstrate the system susceptibility to corona discharge. Such discharge fogs the film thus degrading the operational photography.

2. Test Summary

Performance of the J-29 payload system was generally satisfactory during the environmental test in the TASC Chamber. The test ran from 2-7 October 1965.

Both instruments ran fast throughout the test; the average cycle period was 1.5% fast for both instruments. The instruments ran within $\pm 1\%$ of each other with instrument #2 being generally faster. Excessive coasting was observed for both units during some of the operations at the faster rates. In one instance both units coasted into the scan portion of the cycle. Cycle periods are listed in Table 2-1. Approximately 2800 cycles per instrument per mission were made.

The -1 S/I monitor indicated payload movement during several platen command times. The -2 S/I operated satisfactorily.

The clock performance was satisfactory. Results are listed in Table 2-2.

The pressure make-up system operated normally. The average gas consumption rate of 7.4 psi/min is consistent with previous PMU systems.

The lowest internal payload pressure was 0.8 microns. The corona on the payload was very minor.

Except for several noisy TLM idlers, the instrumentation was normal.

The command system functioned properly for both missions. The RTC switch units stepped to the positions programmed in each case.

The -1 and -2 recovery sequences and vehicle deactivate sequence were satisfactorily performed.

B. RESOLUTION TEST

The dynamic resolution test of the J-29 payload system was performed at the A/P facility on 14 October 1965. Each panoramic camera photographed low contrast resolution targets. The resulting through focus resolution data is shown in Figure 2-1 for the Master camera and in Figure 2-2 for the Slave camera. The resolution performance meets the system requirement specifications.

C. LIGHT LEAK TEST

The examination of the 3401 Type film threaded in the J-29 system during the light leak test determined that the light tight integrity of the system was acceptable for flight.

D. FLIGHT LOADING AND CERTIFICATION

Pan instrument payload exhibits from the flight readiness test were processed and examined on 1 March 1966. Both instruments were acceptable except for excessive amounts of scraped emulsion which caused ragged rail edges and clogged shrinkage markers. On the master instrument, the scraped emulsion also obscured one fiducial mark and caused minus density streaks in the pan format from deposits on the filter. It was therefore necessary to clean both instruments and rerun the test. The second readiness test, also completed on 1 March 1966, showed the system to be in acceptable condition for flight loading.

Loading of the supply cassette and final assembly of the system was performed on 2 March 1966. These operations were completed in a routine manner.

~~TOP SECRET C~~ [REDACTED]
NO. [REDACTED]

The final light leak check showed no leaks except for one at the take-up side of the master instrument drum. The magnitude of this leak was less than similar leaks on several recent flight systems.

The J-29 system performance was considered acceptable and was certified for flight.

~~TOP SECRET C~~ [REDACTED]

~~TOP SECRET C~~

NO. [REDACTED]

PRE-FLIGHT DYNAMIC RESOLUTION

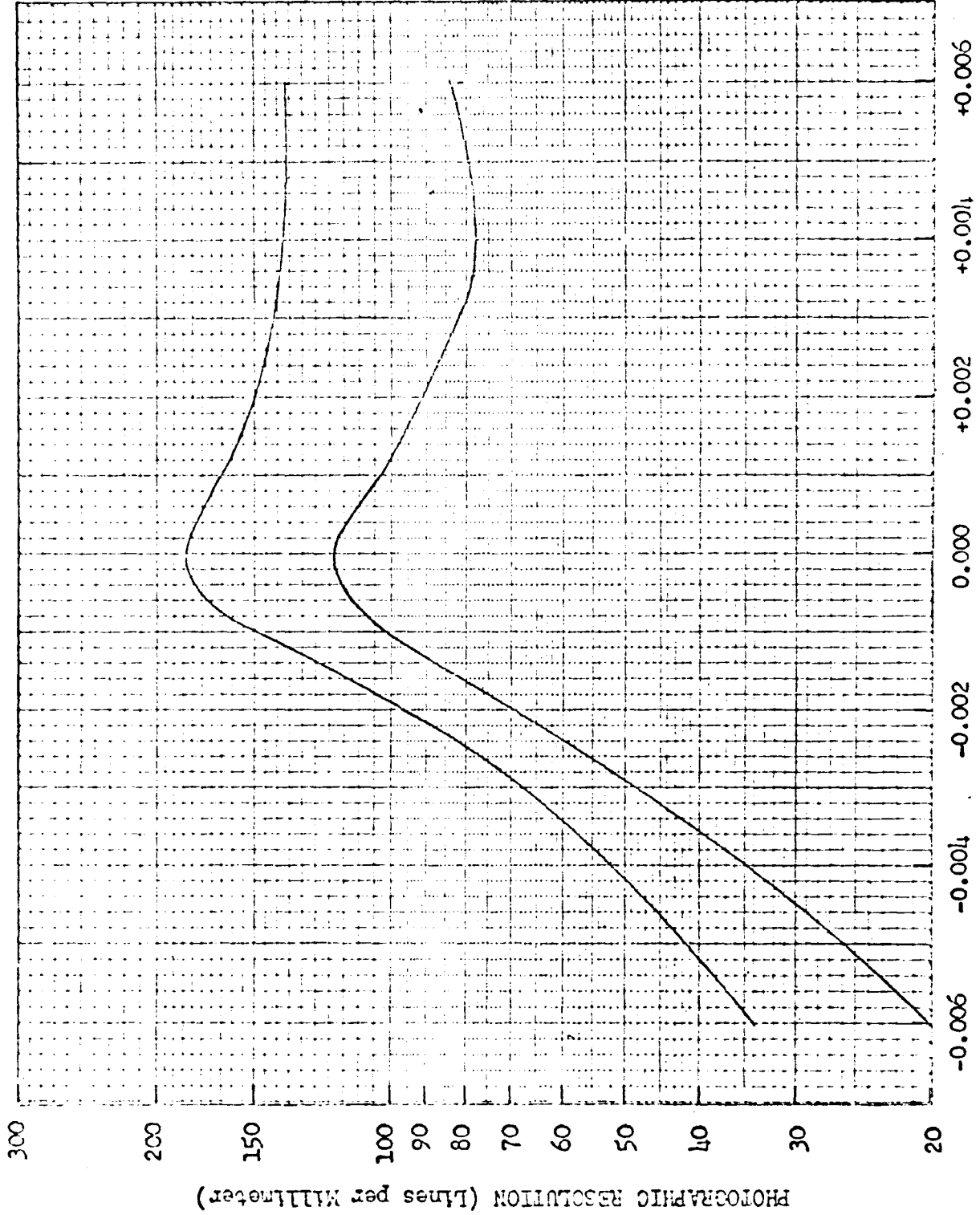

Camera No: 182

Payload No: J-29

Resolution (1/mm) 183

High Contrast: 183

Low Contrast: 118

Film Type: 3404

Test Date: 10/15/65

THROUGH FOCUS INCREMENTS (Inches)

~~TOP SECRET C~~

Figure 2-1

~~TOP SECRET C~~

NO.

PRE-FLIGHT DYNAMIC RESOLUTION

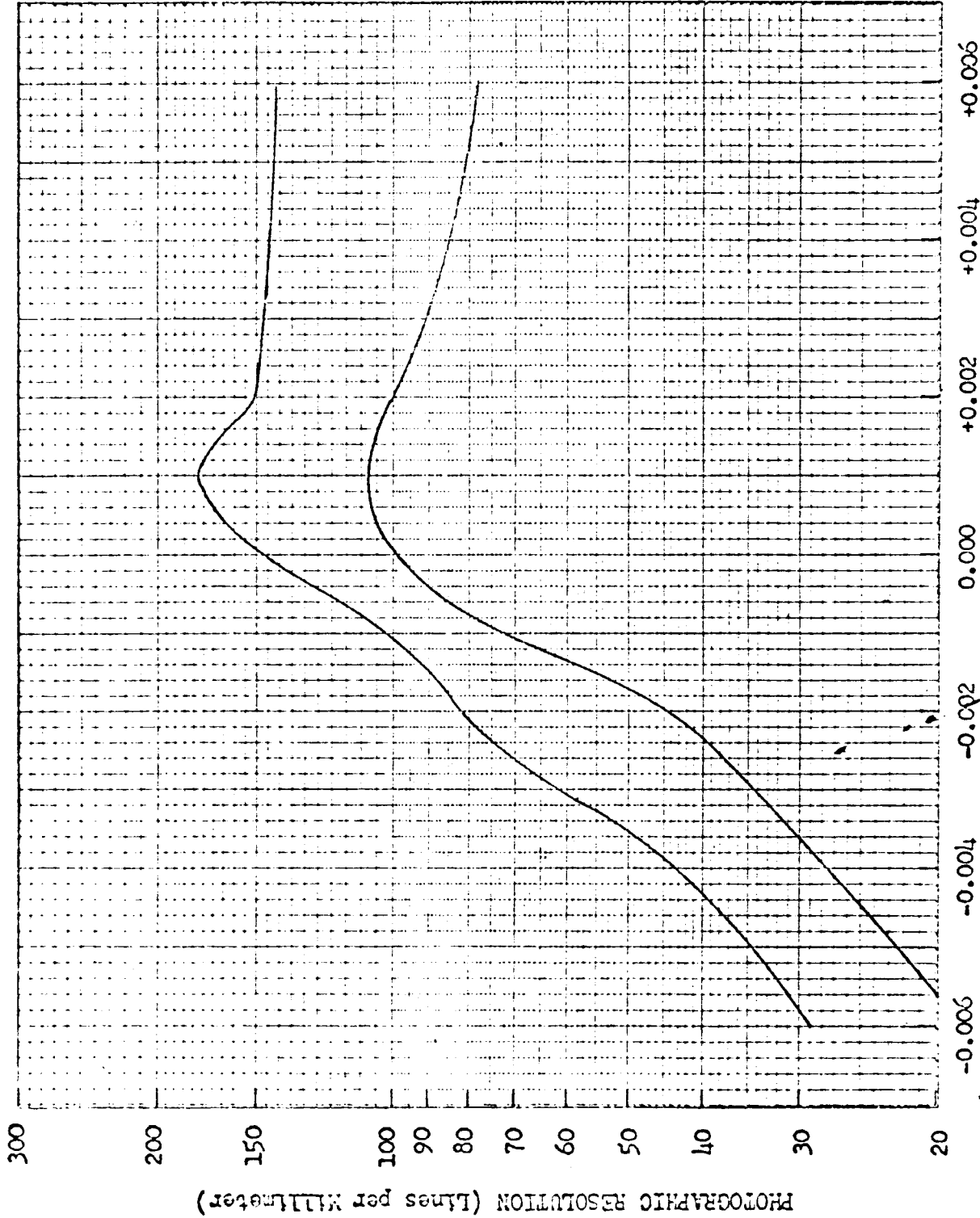

Camera No: 183

Payload No: J-29

Resolution (1/mm): 178

High Contrast: 178

Low Contrast: 103

Film Type: 3404

Test Date: 10/15/65

~~TOP SECRET C~~

Figure 2-2

J-29 182/183 ENVIRONMENTAL TEST

REV/MODE	RAMP	T.U.R.	INST 182			INST 183			182/183 DIFF.	
			ACT.	CAL.	DEV.	ACT.	CAL.	DEV.		
0	A	7 7	0	3.655	3.649	0.16S	3.645	3.642	0.08S	-0.27
0	A	7 7	0	3.650	3.649	0.02S	3.650	3.642	0.21S	-0.00
1	A	7 7	390	3.500	3.513	0.37F	3.500	3.507	0.19F	-0.00
1	A	7 7	2215	2.550	2.555	0.20F	2.550	2.555	0.18F	-0.00
2	A	4 1	2030	2.155	2.187	1.45F	2.150	2.186	1.66F	-0.23
2	A	5 8	825	2.814	2.822	0.27F	2.820	2.819	0.02S	0.21
3	A	5 8	1645	2.390	2.408	0.73F	2.395	2.408	0.55F	0.21
4	A	7 7	2280	2.550	2.587	1.44F	2.555	2.587	1.23F	0.20
4	A	8 2	240	5.280	5.333	0.99F	5.270	5.320	0.94F	-0.19
5	A	11 1	1360	2.760	2.789	1.05F	2.760	2.787	0.98F	-0.00
5	A	11 1	1460	2.570	2.601	1.18F	2.565	2.600	1.34F	-0.19
6	A	11 1	1940	2.235	2.268	1.46F	2.230	2.270	1.75F	-0.22
6	A	5 8	1090	2.660	2.675	0.54F	2.665	2.673	0.31F	0.19
6	A	5 8	1445	2.455	2.476	0.86F	2.455	2.476	0.87F	-0.00
7	A	7 7	1180	2.820	2.847	0.95F	2.830	2.845	0.52F	0.35
7	A	7 7	1590	2.520	2.553	1.28F	2.520	2.552	1.27F	-0.00
8	A	7 7	2430	2.665	2.684	0.71F	2.655	2.683	1.04F	-0.38
8	A	4 1	1015	2.650	2.675	0.93F	2.640	2.674	1.26F	-0.38
9	A	4 1	3210	3.460	3.521	1.72F	3.465	3.514	1.41F	0.14

Table 2-1

REV/MODE	RAMP	T.U.R.	INST 182			INST 183			182/183 DIFF.	
			ACT.	CAL.	DEV.	ACT.	CAL.	DEV.		
9	A	11 1	891	4.300	4.362	1.43F	4.315	4.352	0.85F	0.35
9	A	11 1	1880	2.233	2.266	1.46F	2.225	2.268	1.89F	-0.36
10	A	11 1	3140	5.404	5.546	2.55F	5.432	5.532	1.81F	0.52
10	A	7 7	40	3.580	3.647	1.83F	3.590	3.640	1.37F	0.28
11	A	7 7	1910	2.455	2.484	1.15F	2.445	2.484	1.56F	-0.41
11	A	7 7	2286	2.568	2.591	0.87F	2.568	2.590	0.85F	-0.00
12	A	8 2	1155	2.900	2.916	0.53F	2.895	2.913	0.61F	-0.17
12	A	8 2	845	3.620	3.648	0.76F	3.628	3.641	0.35F	0.22
13	A	4 1	2630	2.365	2.398	1.40F	2.358	2.399	1.72F	-0.30
13	A	11 1	1975	2.253	2.275	0.95F	2.243	2.276	1.46F	-0.44
14	A	11 1	3080	5.120	5.203	1.59F	5.138	5.190	1.00F	0.35
15	A	5 8	0	3.050	3.113	2.02F	3.060	3.109	1.57F	0.33
0	B	6 6	1945	2.270	2.275	0.21F	2.265	2.276	0.50F	-0.22
1	B	7 7	390	3.450	3.513	1.79F	3.455	3.507	1.48F	0.14
1	B	7 7	2450	2.670	2.699	1.08F	2.665	2.698	1.22F	-0.19
1	B	4 1	0	4.300	4.394	2.13F	4.300	4.383	1.90F	-0.00
2	B	4 1	1430	2.170	2.206	1.64F	2.150	2.206	2.53F	-0.92
2	B	4 1	1610	2.160	2.192	1.47F	2.140	2.192	2.36F	-0.93
2	B	4 1	2130	2.155	2.190	1.58F	2.140	2.189	2.24F	-0.70
2	B	5 8	730	2.843	2.873	1.06F	2.835	2.871	1.25F	-0.28
3	B	5 8	1550	2.403	2.436	1.34F	2.408	2.436	1.15F	0.21
3	B	5 8	0	3.068	3.113	1.44F	3.073	3.109	1.15F	0.16

Table E-1

REV/MODE	RAMP	T.U.R.	INST 182			INST 183			182/183 DIFF.	
			ACT.	CAL.	DEV.	ACT.	CAL.	DEV.		
4	B	7 7	2280	2.573	2.587	0.55F	2.573	2.587	0.53F	-0.00
4	B	8 2	440	4.768	4.822	1.12F	4.758	4.810	1.09F	-0.21
5	B	11 1	1460	2.590	2.601	0.41F	2.580	2.600	0.77F	-0.39
5	B	11 1	1940	2.260	2.268	0.36F	2.250	2.270	0.87F	-0.44
6	B	5 8	1090	2.675	2.675	0.02S	2.680	2.673	0.25S	0.19
6	B	5 8	1645	2.388	2.408	0.81F	2.388	2.408	0.84F	-0.00
7	B	7 7	1230	2.783	2.800	0.61F	2.783	2.798	0.54F	-0.00
7	B	7 7	1590	2.538	2.553	0.58F	2.548	2.552	0.17F	0.39
8	B	7 7	2430	2.675	2.684	0.34F	2.680	2.683	0.10F	0.19
8	B	4 1	1015	2.665	2.675	0.37F	2.670	2.674	0.14F	0.19
9	B	4 1	3310	3.755	3.737	0.48S	3.743	3.730	0.36S	-0.32
9	B	11 1	990	3.958	3.965	0.18F	3.973	3.957	0.41S	0.38
10	B	11 1	2080	2.325	2.318	0.29S	2.318	2.320	0.07F	-0.30
10	B	11 1	3170	5.730	5.726	0.07S	5.725	5.712	0.22S	-0.09
10	B	11 1	0	9.070	9.056	0.15S	9.060	9.049	0.12S	-0.11
10	B	7 7	0	3.650	3.649	0.02S	3.640	3.642	0.06F	-0.27

DEV. AND DIFF. ARE IN PERCENT
THE (-) SIGN INDICATES THAT INST 1 IS SLOWER THAN INST 2
F=FAST AND S=SLOW

Table 2-1

J-29 CLCCK/IRIG TIME CHECK

REV	DAY	HR	MIN	SEC	IRIG SECONDS	CLCCK SECONDS	DELTA IRIG	DELTA CLOCK	ERROR
0	275	7	51	57.780	23788317.780	5276.306	---	---	---
1	275	8	30	33.785	23790633.785	7592.329	2316.005	2316.023	0.018
2	275	11	8	14.740	23800094.740	17053.284	9460.955	9460.955	0.000
3	275	12	44	9.880	23805849.880	22806.413	5755.140	5755.129	-0.011
4	275	14	15	0.210	23811300.210	28258.750	5450.330	5450.337	0.007
5	275	15	29	10.050	23815750.050	32708.592	4449.840	4449.842	0.002
6	276	8	1	46.120	23875306.120	42264.655	59556.070	59556.063	-0.007
7	276	9	27	36.475	23880456.475	97415.004	5150.355	5150.349	-0.006
8	276	11	0	6.350	23886006.350	102964.886	5549.875	5549.882	0.007
9	276	13	28	33.375	23894913.375	111871.919	8907.025	8907.033	0.008
10	276	15	11	4.140	23901064.140	118022.668	6150.765	6150.749	-0.016
11	277	8	13	45.220	23962425.220	179383.742	61361.080	61361.074	-0.006
12	277	9	31	15.323	23967075.323	184033.839	4650.103	4650.097	-0.006
13	277	10	57	5.345	23972225.345	189183.887	5150.022	5150.048	0.026
14	277	12	35	25.359	23978125.359	195083.872	5900.014	5899.985	-0.029
1	279	10	1	6.390	24141660.390	358624.881	163541.028	163541.006	-0.021
2	279	12	38	36.405	24151110.405	368074.906	9450.015	9450.025	0.010
3	279	14	14	31.545	24156871.545	373830.039	5755.140	5755.133	-0.007
4	279	15	45	21.425	24162321.425	379279.913	5449.880	5449.874	-0.006
5	279	16	59	31.632	24166771.632	383730.126	4450.207	4450.213	0.006
4	9	7	33.851	-DELTA TIME			TOTAL ACCUM. ERROR -0.031		
POWER DOWN									
6	280	8	59	52.960	24224392.960	9464.737	---	---	---
7	280	10	42	23.355	24230543.355	15615.131	6150.395	6150.394	-0.001
8	280	12	59	2.145	24238742.145	23813.924	8198.790	8198.793	0.003
9	280	14	33	12.260	24244392.260	29464.039	5650.115	5650.115	0.000
10	280	16	15	42.775	24250542.775	35614.551	6150.515	6150.512	-0.003
0	7	15	49.815	-DELTA TIME			TOTAL ACCUM. ERROR -0.001		

Table 2-2

SECTION 3

FLIGHT OPERATIONS

A. SUMMARY

All launch, ascent, and injection events occurred as programmed. All Thor and Agena events were normal which resulted in achieving the desired orbit.

Both panoramic instruments operated satisfactorily throughout the flight. Average cycle rates on both units deviated from the pre-flight calibrated values by less than 1.0%.

The -1 and -2 Stellar/Index cameras operated normally throughout the flight.

The clock, instrumentation, and the PMU systems functioned properly throughout the flight.

The command system performed satisfactorily except for the V/h delay stepper switch which failed to home in position one on numerous occasions throughout the flight.

Both the -1 and -2 recovery systems were successfully recovered by air catch on orbits 81 and 159, respectively.

B. PANORAMIC CAMERA PERFORMANCE

Camera system dynamics were normal throughout the -1 and -2 missions. The film transport of both camera systems was normal. Cycle rate data (Table 3-1) indicates that the camera systems were generally less than 0.75% from the calibrated systems value. The master and slave instruments were generally less than 1.0% apart throughout most of the flight. The 99/101 average clutch ratio was 6/6 for both instruments. Camera film depletion occurred prior to the engineering operation on Rev. 151.



Panoramic film consumption

These data are based on cycle counter readings and nominal film supply.

	Predicted		Actual	
	<u>Master</u>	<u>Slave</u>	<u>Master</u>	<u>Slave</u>
Pre-Launch	110	110	102	110
-1 Mission	3000	3000	2956	2945
-2 Mission	2935	2935	2991	2995
Total Frames	6045	6045	6049	6050

FMC Match

The RTC command setup (R8-A3-D7) provided a good match between the calibrated rates and the orbit rate requirements throughout the mission. Normal operations occurred well within acceptable tolerance, especially during -1 phase of the mission. However, the malfunctioning of the V/h delay start selector switch caused occasional FMC errors as high as 20%. An error of this magnitude could produce noticeable smear on the photography.

The V/h programmer usually started at the desired delay step or one step later. Therefore, the RTC command setup was changed (R7-A3-D6) to insure the most favorable ramp match. However, when the V/h delay failed to start in either of these positions, excessive FMC errors were produced.

C. INSTRUMENTATION AND COMMAND SYSTEM PERFORMANCE

Instrumentation System Performance

The instrumentation system performed satisfactorily throughout both missions except for points 1 (cal 1/2) and 2 (RTC 6 tens position) on channel 13. These two points on the commutator indicated the same voltage value beginning on Rev 87 of the -2 mission. This condition was present until sometime between the engineering passes on Rev 103 and



110. Both these points indicated the proper voltage levels on the engineering pass on Rev 110 and throughout the remainder of the mission. The cause of this anomaly remains unresolved.

Command System Performance

The payload system responded to all stored and real time commands except for the erratic homing of the V/h delay stepper switch. This anomaly was first encountered on the "Post-Mate Confidence" prior to launch. A special confidence re-run was conducted to insure satisfactory performance of the V/h delay stepper switch. The V/h delay stepper switch was given a homing command five different times. The stepper switch failed to home properly on the first two attempts stopping in position 11. On these two attempts the unregulated voltage was set at 28 volts and 26 volts respectively. The unregulated voltage was then set at 24 volts and the V/h delay stepper switch homed properly to position 1 on the next three attempts.

The vehicle unregulated voltage was predicted to drop to approximately 24 volts after the second day of the mission. It was, therefore, decided to proceed with the launch and if necessary, adjust the ramp, amplitude, and V/h delay start position to compensate for erratic homing.

Refer to Table 3-2 for the orbits in which the V/h delay switch failed to home in the proper position.

The problem of the erratic homing of the V/h stepper switch has been attributed to the installation of two spark suppression diodes in this circuit. A decision was, therefore, made to remove these two diodes from all subsequent systems.

D. CLOCK SYSTEM PERFORMANCE

The payload clock system performed satisfactorily during both phases of the mission. The clock/system time correlation data obtained from the [REDACTED] acquisitions are included in Table 3-3.

E. PRESSURE MAKE-UP SYSTEM PERFORMANCE

The pressure make-up system operated normally throughout the flight. The average gas consumption was 7.7 psi/min. for a total instrument operate time of 249 minutes. The supply pressure dropped from 2350 psig at launch to 420 psig at the end of the -2 mission.

The average gas consumption rate was 7.5 psi/min. for the -1 mission and 8.0 psi/min. for the -2 mission.

F. THERMAL ENVIRONMENT

The temperature data obtained from the [REDACTED] acquisitions are contained in Table 3-4. Average panoramic camera temperatures for the master camera varied from 89°F to 72°F and the slave camera temperatures varied from 83°F to 64°F during the mission. The actual system temperatures versus the predicted system temperatures for the major components are compared in Figures 3-1 to 3-3.

G. STELLAR/INDEX CAMERA PERFORMANCE

The -1 stellar/index camera operation was normal throughout the mission with telemetry indicating proper metering and shutter operation.

The -2 stellar/index camera operation was also normal throughout the mission with no abnormalities noted in telemetry.

J-29 182/183 FLIGHT CYCLE RATES

REV. MODE	CP	RAMP R	TUR A	SYSTEM SECS CALIB.	I-----INST. 182-----I			I-----INST. 183-----I			182/183 DIFF.	
					ACTUAL	UNIT DEV.	SYSTEM DEV.	ACTUAL	UNIT DEV.	SYSTEM DEV.		
09	A	8	3	120	5.132	5.055	1.62F	1.50F	5.045	1.58F	1.70F	-0.20
16	A	8	3	1685	2.263	2.280	0.79S	0.75S	2.260	0.17F	0.14F	-0.88
31	A	7	3	1869	2.216	2.215	0.04F	0.03F	2.220	0.21S	0.20S	0.23
47	A	7	3	1642	2.224	2.242	0.80S	0.81S	2.223	0.04F	0.05F	-0.85
63	A	7	3	1700	2.221	2.228	0.32S	0.33S	2.232	0.53S	0.51S	0.18
79	A	7	3	1660	2.223	2.230	0.31S	0.32S				
88	B	7	3	249	4.609	4.605	0.21F	0.09F	4.590	0.29F	0.41F	-0.33
94	B	7	3	1823	2.216	2.251	1.56S	1.57S	2.231	0.68S	0.66S	-0.89
103	B	7	3	340	4.459	4.553	1.99S	2.11S	4.574	2.70S	2.58S	0.40
110	B	7	3	1903	2.216	2.232	0.73S	0.74S	2.217	0.08S	0.07S	-0.67
126	B	7	3	1911	2.216	2.233	0.78S	0.79S	2.224	0.39S	0.38S	-0.40

DEV. AND DIFF. ARE IN PERCENT
THE (-) SIGN INDICATES THAT INST 1. IS SLOWER THAN INST 2
F=FAST AND S=SLOW

Table 3-1

ABNORMAL V/H DELAY HOME POSITION

<u>Rev.</u>	<u>Station</u>	<u>Stepper Switch Home Position</u>	<u>V/H Start Position Error</u>
29		11	60 Seconds Late
42		11	60 Seconds Late
44		11	60 Seconds Late
71		11	60 Seconds Late
74		11	60 Seconds Late
80		11	60 Seconds Late
87		11	60 Seconds Late
89		11	60 Seconds Late
91		11	60 Seconds Late
95		11	60 Seconds Late
101		11	60 Seconds Late
104		11	60 Seconds Late
106		11	60 Seconds Late
108		8	240 Seconds Late
111		10	120 Seconds Late
115		7	300 Seconds Late
117		6	300 Seconds Early
119		11	60 Seconds Late
121		7	300 Seconds Late
123		11	60 Seconds Late
126		11	60 Seconds Late
131		11	60 Seconds Late
133		11	60 Seconds Late
135		11	60 Seconds Late
136		7	300 Seconds Late
139		11	60 Seconds Late
142		4	180 Seconds Early
150		11	60 Seconds Late
152		4	180 Seconds Early
153		11	60 Seconds Late
155		7	300 Seconds Late
158		11	60 Seconds Late
159		11	60 Seconds Late

Table 3-2

ORDER FIT 1		CL TIME 1/P		COMP SYS TM	DELTA ST	REV	STA
0.40261430	05	0.1428123150	06	0.402614430	05	-0.0018	9
0.402628430	05	0.1424993250	06	0.4026284160	05	0.0016	16
0.357728500	05	0.2243590510	06	0.3577285120	05	-0.0012	24
0.754452300	05	0.2647344750	06	0.7544523350	05	-0.0038	31
0.364021700	05	0.3113684040	06	0.3640217260	05	0.0034	40
0.760117300	05	0.3509979830	06	0.7601173730	05	-0.0023	47
0.370335500	05	0.3983898210	06	0.370335510	05	-0.0001	56
0.765995500	05	0.4379858320	06	0.7659955470	05	-0.0047	63
0.375304800	05	0.4853167770	06	0.3753048250	05	0.0035	72
0.771700300	05	0.5249627530	06	0.771700310	05	0.0089	79
0.381199710	05	0.5543536700	06	0.3811997290	05	-0.0019	88
0.721761230	05	0.6949154560	06	0.7217611860	05	0.0044	94
0.331336640	05	0.1168541050	06	0.3313366140	05	0.0026	103
0.726884300	05	0.1564039010	06	0.726884330	05	-0.0040	110
0.336228930	05	0.2837363650	06	0.3362289390	05	0.0041	119
0.731551930	05	0.2432706930	06	0.7315520350	05	-0.0105	126
0.340759770	05	0.2905914800	06	0.3407597330	05	0.0037	135
0.345007700	05	0.3774163160	06	0.3450077760	05	-0.0016	151

AG=-0.10216011045 06 AI= 0.999996370750 00

SIGMA=0.0024 NO. POINTS= 10

RATIO OF CLOCK TIME TO SYS TIME= 0.100000302930 01

ORDER FIT 2		CL TIME 1/P		COMP SYS TM	DELTA ST	REV	STA
0.40261430	05	0.1428123150	06	0.402614300	05	0.0000	9
0.402628430	05	0.1424993250	06	0.4026284020	05	0.0028	16
0.357728500	05	0.2243590510	06	0.3577285050	05	-0.0005	24
0.754452300	05	0.2647344750	06	0.754452360	05	-0.0036	31
0.364021700	05	0.3113684040	06	0.3640217290	05	0.0031	40
0.760117300	05	0.3509979830	06	0.7601173780	05	-0.0028	47
0.370335500	05	0.3983898210	06	0.370335580	05	-0.0009	56
0.765995500	05	0.4379858320	06	0.765995560	05	-0.0056	63
0.375304800	05	0.4853167770	06	0.3753048360	05	0.0024	72
0.771700300	05	0.5249627530	06	0.7717003020	05	0.0078	79
0.381199710	05	0.5543536700	06	0.3811997400	05	-0.0030	88
0.721761230	05	0.6949154560	06	0.7217611950	05	0.0035	94
0.331336640	05	0.1168541050	06	0.3313366210	05	0.0019	103
0.726884300	05	0.1564039010	06	0.726884340	05	-0.0044	110
0.336228930	05	0.2837363650	06	0.3362289390	05	0.0041	119
0.731551930	05	0.2432706930	06	0.7315520310	05	-0.0101	126
0.340759770	05	0.2905914800	06	0.3407597230	05	0.0047	135
0.345007700	05	0.3774163160	06	0.3450077550	05	0.0005	151

AG=-0.10216012260 06 AI= 0.9999996567620 00

A2=-0.21095698357500-13

SIGMA=0.00413 NO. POINTS= 18

Table 3-3

TABLE 3-4

J-29 TEMPERATURE SUMMARY

<u>SENSOR</u>	<u>ORBITS ACQUIRED</u>																				
											<u>A</u>	<u>B</u>									
<u>Master Camera</u>	<u>0</u>	<u>9</u>	<u>16</u>	<u>24</u>	<u>31</u>	<u>40</u>	<u>47</u>	<u>56</u>	<u>63</u>	<u>72</u>	<u>79</u>	<u>88</u>	<u>94</u>	<u>103</u>	<u>110C</u>	<u>119</u>	<u>126</u>	<u>135</u>	<u>151</u>		
3	60	61	79	82	80	80	78	80	76	78	73	74	68	70	65	69	65	69	70		
4	58	64	81	84	81	83	79	82	77	80	73	76	69	72	67	71	66	70	70		
5	58	90	86	89	86	87	84	87	82	84	80	80	75	77	73	75	70	74	73		
6	57	90+	93	95	92	93	89	91	87	89	84	84	78	79	77	75	73	74	74		
7	54	90	87	89	88	87	85	86	83	84	81	79	75	75	73	73	70	71	71		
8	61	90	87	90	86	88	84	88	82	86	80	81	75	78	74	77	71	75	75		
9	59	90	92	96	92	93	88	92	86	90	84	85	79	82	76	80	73	78	78		
10	--	--	--	--	--	--	--	--	--	--	--	--	--	--	--	--	--	--	--		
11	65	94	93	95	93	93	89	90	85	88	83	80	74	78	72	75	70	71	70		
12	62	82	79	82	80	81	77	81	75	80	73	76	68	73	66	72	65	70	72		
13	54	90	87	89	88	86	84	85	81	83	79	76	70	72	68	69	68	68	68		
AVG	59	89	86	89	87	87	84	86	81	84	78	78	73	76	72	74	69	72	72		
<u>Slave Camera</u>																					
3	57	69	87	88	87	87	84	85	81	82	77	77	71	72	69	70	65	67	66		
4	54	83	78	83	79	81	77	81	76	78	72	74	67	70	65	68	62	65	64		
5	52	83	80	84	81	82	79	82	77	79	74	75	70	71	68	68	64	68	67		
6	56	83	81	83	82	82	80	81	79	80	76	75	70	71	69	69	66	68	70		
7	52	85	82	85	83	82	81	81	80	81	78	76	69	72	69	70	67	68	68		
8	55	85	82	84	82	83	80	83	79	82	76	78	71	74	69	72	67	71	71		
9	56	82	79	81	80	80	78	80	77	80	75	76	69	72	68	71	66	70	71		
10	--	--	--	--	--	--	--	--	--	--	--	--	--	--	--	--	--	--	--		
11	58	72	70	71	72	70	69	71	68	69	66	65	62	61	60	60	56	58	59		
12	56	86	80	86	81	85	78	82	76	79	73	76	68	73	66	69	63	66	66		
13	53	80	80	81	82	79	78	79	76	77	74	71	67	67	64	65	64	64	64		
AVG	57	83	80	83	82	81	78	80	77	79	74	74	68	70	67	68	64	66	67		
<u>Supply</u>																					
1	55	64	65	67	67	67	67	69	67	68	64	64	60	60	58	59	56	57	58		
2	59	73	71	76	74	75	72	76	71	74	69	69	63	65	63	63	59	62	61		

Note: All data corrected for self-heating, except injection.

TABLE 3-4

J-29 TEMPERATURE SUMMARY

SENSOR	ORBITS ACQUIRED																			
	A B																			
Fair ("A")																				
Barrel #1 ("B")	0	9	16	24	31	40	47	56	63	72	79	88	94	103	110	119	126	135	151	
1	OBH	36	49	39	49	29	42	33	42	26	39	18	34	18	34	15	28	15	15	
2	OBH	3	-4	7	-4	3	-4	3	-4	3	-8	55	45	55	51	55	48	55	58	
3	OBH	-7	-4	-7	4	-11	0	-11	4	-11	-4	71	109	67	106	71	106	67	67	
4	208	54	51	54	54	45	48	48	48	41	38	41	80	38	71	35	61	28	28	
5	227	64	60	64	67	54	64	57	54	47	41	39	52	35	48	32	42	25	25	
6	OBH	60	23	63	90	50	79	53	69	44	60	--	--	--	--	--	--	--	--	
Barrel No. 2																				
1		125	52	77	52	68	39	68	45	58	35	45	32	42	29	35	22	29	22	19
2	CHEN	50	103	50	97	40	91	44	85	37	76	37	73	34	66	30	53	27	24	
3	206	64	103	67	106	61	103	64	103	61	103	64	100	64	103	64	97	61	61	
4	227	51	44	54	48	43	48	51	48	51	44	51	44	51	48	51	48	51	57	
5	200	49	59	56	62	49	62	52	62	46	52	39	46	36	46	36	42	32	36	
Conic Adapter																				
1		137	55	68	55	65	49	58	49	52	39	42	33	33	29	26	26	19	19	19
Clock																				
1		79	69	67	73	69	67	67	69	67	65	61	59	53	57	53	55	51	53	53
2		83	71	69	73	71	69	67	69	67	67	61	61	55	57	53	57	53	53	53
Thrust Line "A" to "B" SRV																				
1		70	46	41	45	41	42	40	42	38	40	35	63	59	60	58	58	57	58	58
2		64	70	63	66	60	63	58	60	56	58	51	72	67	69	65	65	63	64	64
Ste'lax/Inlex "A" & "B"																				
1		--	--	--	--	--	--	--	--	--	--	--	43	78	39	72	36	62	33	26
2		--	--	--	--	--	--	--	--	--	--	--	34	47	31	41	28	34	21	21
Recovery Battery "B" SRV																				
1		61	70	72	72	75	66	72	70	70	67	66	79	83	86	81	87	86	86	86
Master Cassette "A" SRV																				
2		92	70	67	69	68	71	67	68	67	66	65	--	--	--	--	--	--	--	--

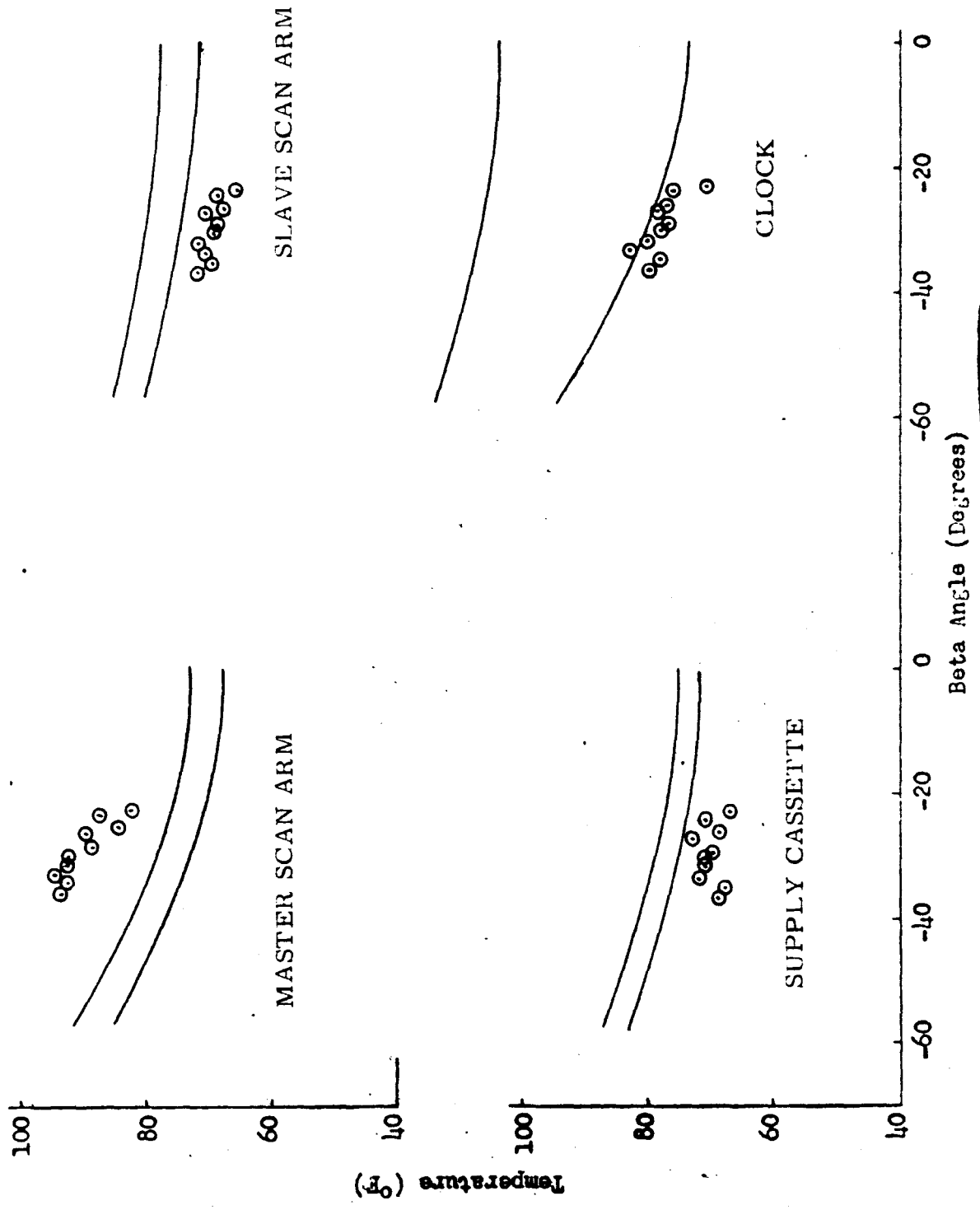
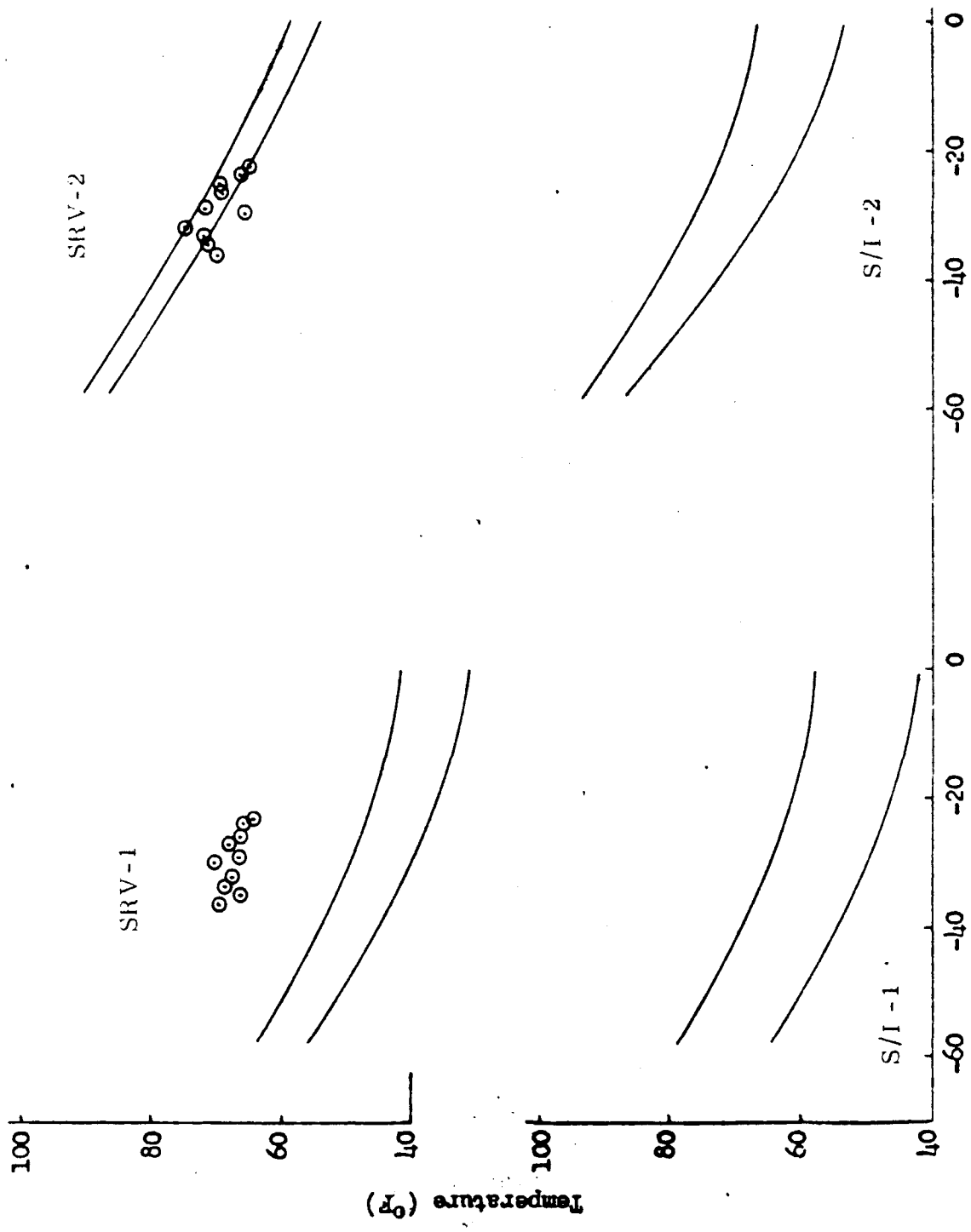
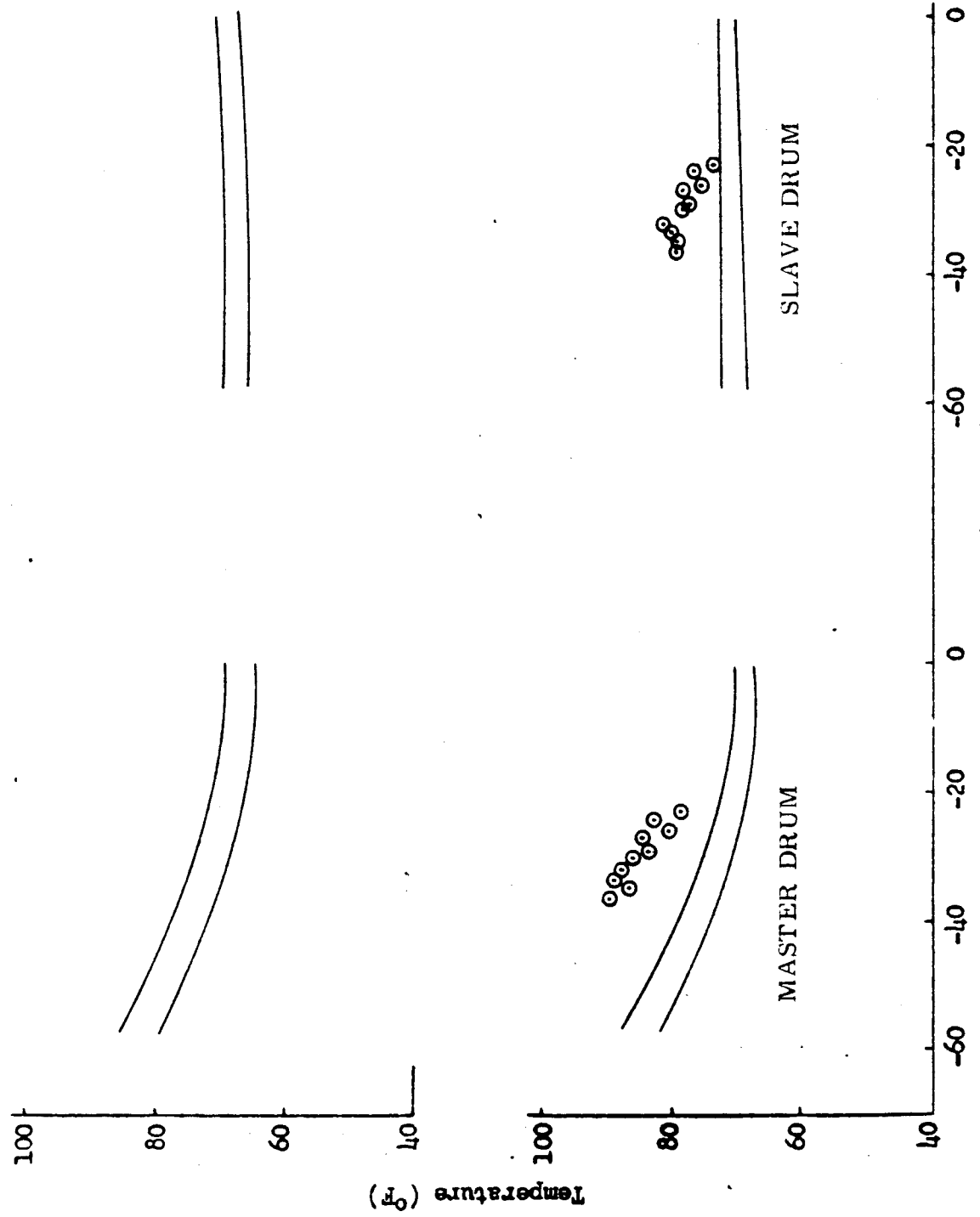

Figure 3-1



Beta Angle (Degrees)

TOP SECRET C
NO. [REDACTED]



TOP SECRET C [REDACTED]

Figure 3-3

SECTION 4

MISSION 1030-1 RECOVERY SYSTEM

SRV #709 was received at A/P on 16 July 1965. The receiving weight was 149.5 pounds. After modification and incorporation of outstanding E.O.'s, the SRV was delivered to Systems Test for mating to the J-29 system. The capsule was delivered to VAFB on 24 January 1966.

-1 Mission

The -1 recovery system was successfully recovered by air catch on orbit 31, March 14, 1966.

Impact Point

Predicted

23° 33' N 168° 55' W

Actual

23° 26' N 168° 37' W

The sequence of re-entry events is contained in Table 4-1.

MISSION 1030-1

RECOVERY SEQUENCE OF EVENTS

<u>Event</u>	<u>Delta Time (Seconds)</u>	
	<u>Actual</u>	<u>Nominal Events + Δ T</u>
*Arm	76.73	77 <u>+</u> 1.0
*Transfer	2.0	2.0 <u>+</u> 0.25
Electrical Disconnect	0.86	0.900 ^{+0.430} - 0.400
**Spin	3.42	3.4 <u>+</u> 0.30
Retro	7.52	7.55 <u>+</u> 0.45
Despin	10.55	10.75 <u>+</u> 0.59
T/C Separation	1.51	1.5 <u>+</u> 0.15
***"G" Switch Open	486.39	491.8 to 502.6
Parachute Cover Off	33.98	34.0 <u>+</u> 1.5
Drogue Chute Deployed	0.66	0.63 <u>+</u> 0.08
Main Chute Bag Separate	9.97	10.14 ^{+.48} - .40
Main Chute Deployed	0.43	0.52 <u>+</u> .13
Main Chute Disreef	4.63	4.46 ^{+.49} - .29

- * From Separation
- ** From Electrical
- *** From Retro

Spin Rate: 64 RPM
Despin Rate: N/A
Retro Velocities: 1075.8 Ft/Sec.

TABLE 4-1

SECTION 5

MISSION 1030-2 RECOVERY SYSTEM

SRV #710 was received at A/P on 16 July 1965. The receiving weight was 149.6 pounds. After modification and incorporation of outstanding E.O.'s the SRV was delivered to Systems Test for mating to the J-29 system. The capsule was delivered to VAFB on 24 January 1966.

-2 Mission

The -2 recovery system was successfully recovered by air catch on orbit 159, March 19, 1966.

<u>Predicted</u>	<u>Impact Point</u>	<u>Actual</u>	
22° 35' N	148° 22' W	22° 42' N	148° 14' W

All recovery events occurred within tolerances. The detailed recovery event times are contained in Table 5-1.

MISSION 1030-2

RECOVERY SEQUENCE OF EVENTS

<u>Event</u>	<u>Actual</u>	Delta Time (Seconds)	
		<u>Nominal</u>	<u>Events + Δ T</u>
*Arm	76.96	77	+ 1.0
*Transfer	2.0	2.0	+ 0.25
Electrical Disconnect	0.97	0.900	+ 0.430 - 0.400
Separation	--	--	--
**Spin	3.37	3.4	+ 0.30
Retro	7.55	7.55	+ 0.45
Despin	10.72	10.75	+ 0.59
T/C Separation	1.55	1.5	+ 0.15
***"G" Switch Open	500.23	491.8 to 502.6	
Parachute Cover Off	33.43	34.0	+ 1.5
Drogue Chute Deployed	0.75	0.63	+ .08
Main Chute Bag Separate	9.50	10.14	+ .48 - .40
Main Chute Deployed	0.43	0.52	+ .13
Main Chute Disreef	4.49	4.46	+ .49 - .29

- * From Separation
- ** From Electrical Disconnect
- *** From Retro

Spin Rate: 64 RPM
Despin Rate: 9.5 RPM
Retro Velocity: 966.4 Ft/Sec.

TABLE 5-1

SECTION 6

MASTER PANORAMIC CAMERA

A. COMPONENT ASSIGNMENT

<u>Component</u>	<u>Serial Number</u>
Main Camera	182
Main Camera Lens	1902435
Supply Horizon Camera	281-G4
Supply Horizon Camera Lens	E12864
Take-up Horizon Camera	284-G3
Take-up Horizon Camera Lens	E12876
Supply Cassette	SC-29

B. CAMERA DATA AND FLIGHT SETTINGS

Main Camera:

Lens	24" f/3.5
Slit Width	0.275"
Filter Type	Wratten 25
Film Type	Eastman Type 3404

Supply (Port) Horizon Camera:

Lens	55 mm f/6.3
Aperture Setting	f/6.3
Exposure Time	1/100 second
Filter Type	Wratten 25

Take-up (Starboard) Horizon Camera:

Lens	55 mm f/6.3
Aperture Setting	f/8.0
Exposure Time	1/100
Filter Type	Wratten 25

C. POST FLIGHT PERFORMANCE EVALUATION

The overall photographic quality of this mission was low due to severe haze layers over many targets. This caused the contrast to be drastically reduced. The segments of the mission in clear weather displayed excellent image quality.

The measured minimum densities were higher than on previous Corona missions. The correlation between these densities and mission performance will not be fully understood until a research analysis is undertaken. It is noted that this mission received a comparatively low percentage of full processing.

The starboard looking horizon cameras produced poor, but useable imagery early in the mission. As the flight progressed the imagery degraded to a useless condition. They started to clear on pass D-98 and after pass D-132 they were normal. There is no assignable cause at this time for this condition.

The end of pass marker was missing on the film from the master instrument. The pre-flight material indicated that it was operational prior to lift-off so it is surmised that ascent vibration caused the anomaly.

The following characteristic anomalies were normal; format and rail scratches, ragged format edges, edge static and light leaks. These items warrant attention to prevent increased degradation.

SECTION 7

SLAVE PANORAMIC CAMERA

A. COMPONENT ASSIGNMENT

<u>Component</u>	<u>Serial Number</u>
Main Camera	183
Main Camera Lens	1882435
Supply Horizon Camera	301-G6
Supply Horizon Camera Lens	E12845
Take-up Horizon Camera	301-G5
Take-up Horizon Camera Lens	E12844
Supply Cassette	SC-29

B. CAMERA DATA AND FLIGHT SETTINGS

Main Camera:

Lens	24" f/3.5
Slit Width	0.175
Filter Type	Wratten 21
Film Type	Eastman Type 3404

Supply (Starboard) Horizon Camera:

Lens	55 mm f/6.3
Aperture Setting	f/8.0
Exposure Time	1/100 second
Filter Type	Wratten 25

Take-up (Port) Horizon Camera:

Lens	55 mm, f/6.3
Aperture Setting	f/6.3
Exposure Time	1/100 second
Filter Type	Wratten 25

SECTION 8

PANORAMIC CAMERA EXPOSURE

The Master camera contained a 0.275 inch slit with a Wratten 25 filter while the Slave camera used a 0.175 inch slit with a Wratten 21 filter. The nominal exposure times for the Master and Slave instruments are shown as a function of latitude for passes 8, 56, 103 and 151 in Figures 8-5 to 8-12. The frequency distributions of the solar elevations and solar azimuths encountered during photographic operations are shown in Figures 8-1 to 8-4.

The predicted level of processing for the original negative is based on the in-flight performance estimate and is tabulated below with the processing levels reported by

<u>Mission/Camera</u>		<u>Primary</u>	<u>Intermediate</u>	<u>Full</u>
1030-1/FWD	Predicted	0%	58%	42%
	Actual	3%	31.7%	65.3%
1030-1/AFT	Predicted	0%	53%	47%
	Actual	0.2%	45.6%	54.2%
1030-2/FWD	Predicted	1%	42%	57%
	Actual	0.1%	52.5%	47.4%
1030-2/AFT	Predicted	1%	23%	76%
	Actual	0.2%	28.3%	71.5%

TOP SECRET (NO.)

SOLAR ELEVATION FREQUENCY DISTRIBUTION

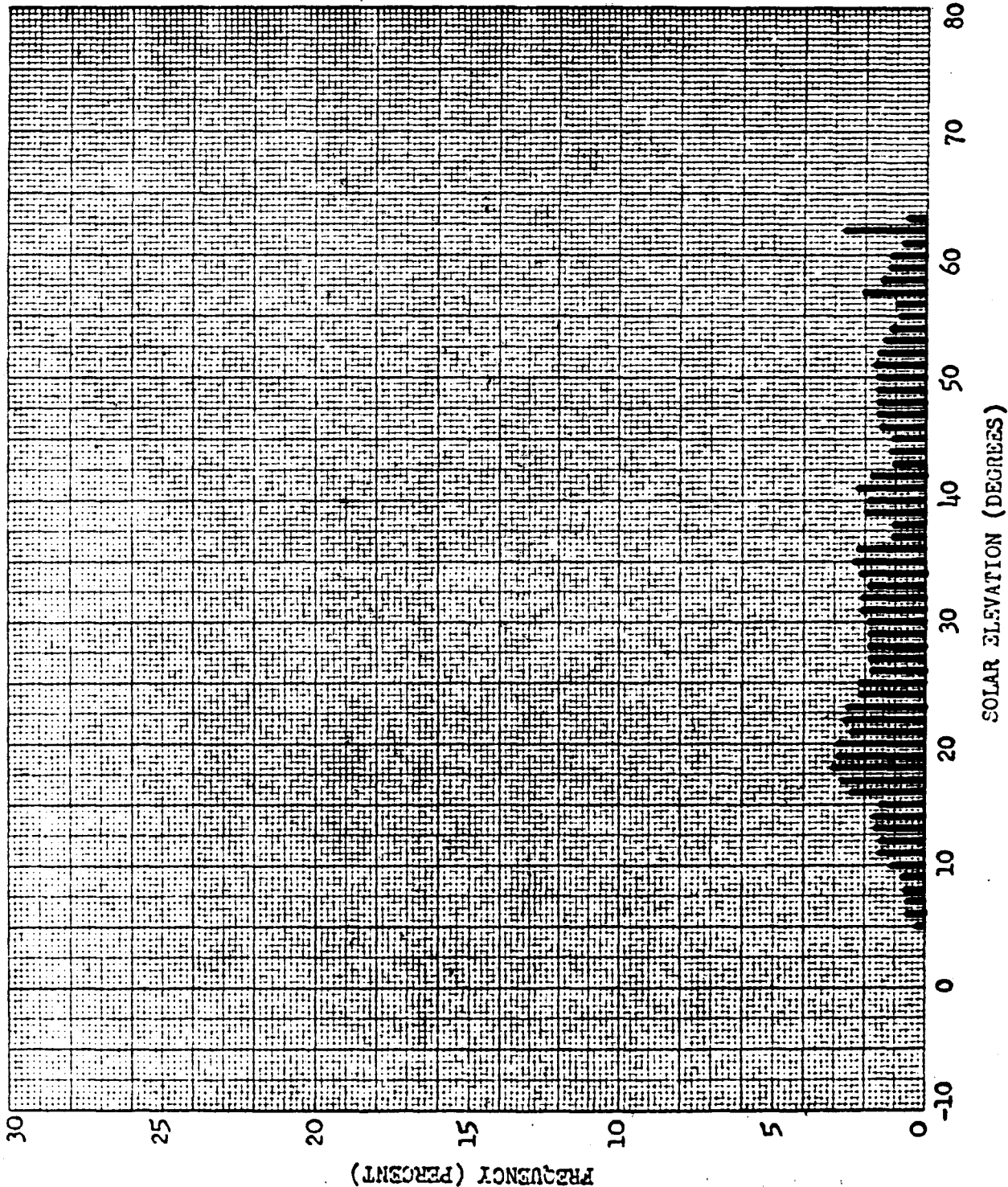

Mission No: 1030-1
Payload No: J-29
Camera No: 182
Launch Date: 3/9/66
Launch Time: 2202 Z
Inclination: 75°

TOP SECRET (NO.)

Figure 8-1

NO. [REDACTED]

SOLAR AZIMUTH FREQUENCY DISTRIBUTION

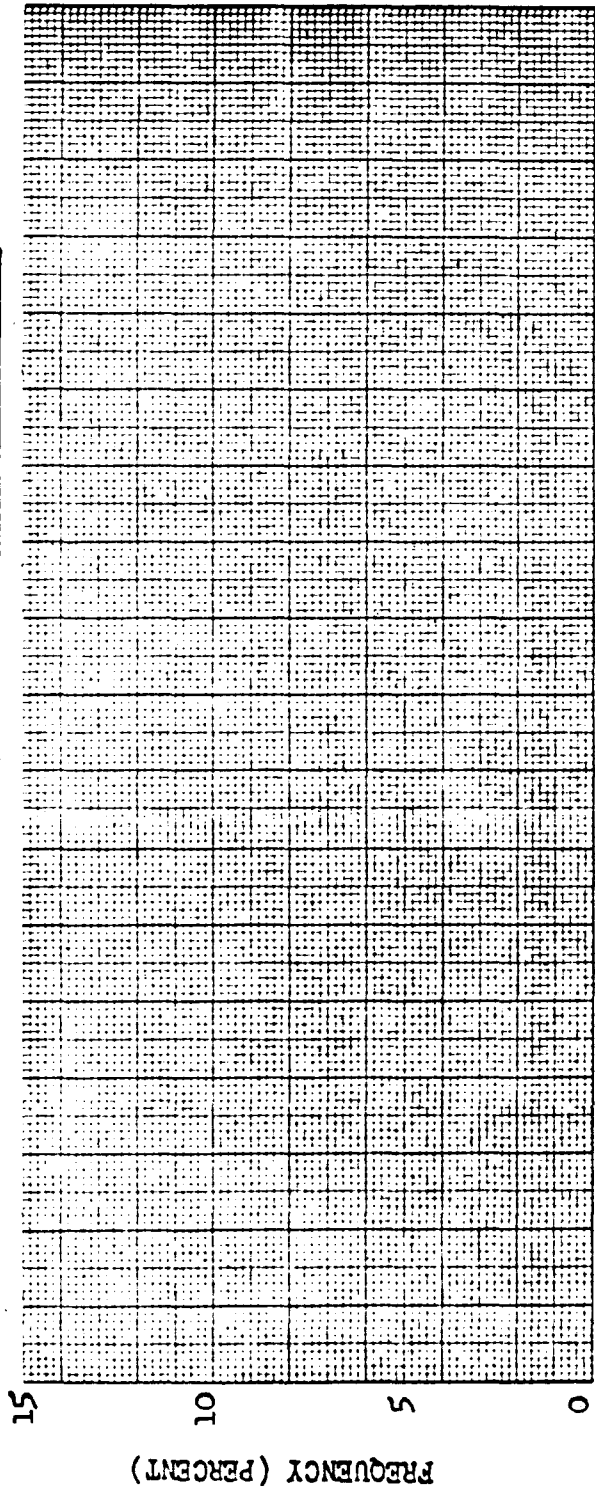

-180

-150

-120

-90

-60

-30

0

FREQUENCY (PERCENT)

Mission No: 1030-1
Payload No: J-29
Camera No: 182
Launch Date: 3/9/66
Launch Time: 2202 Z

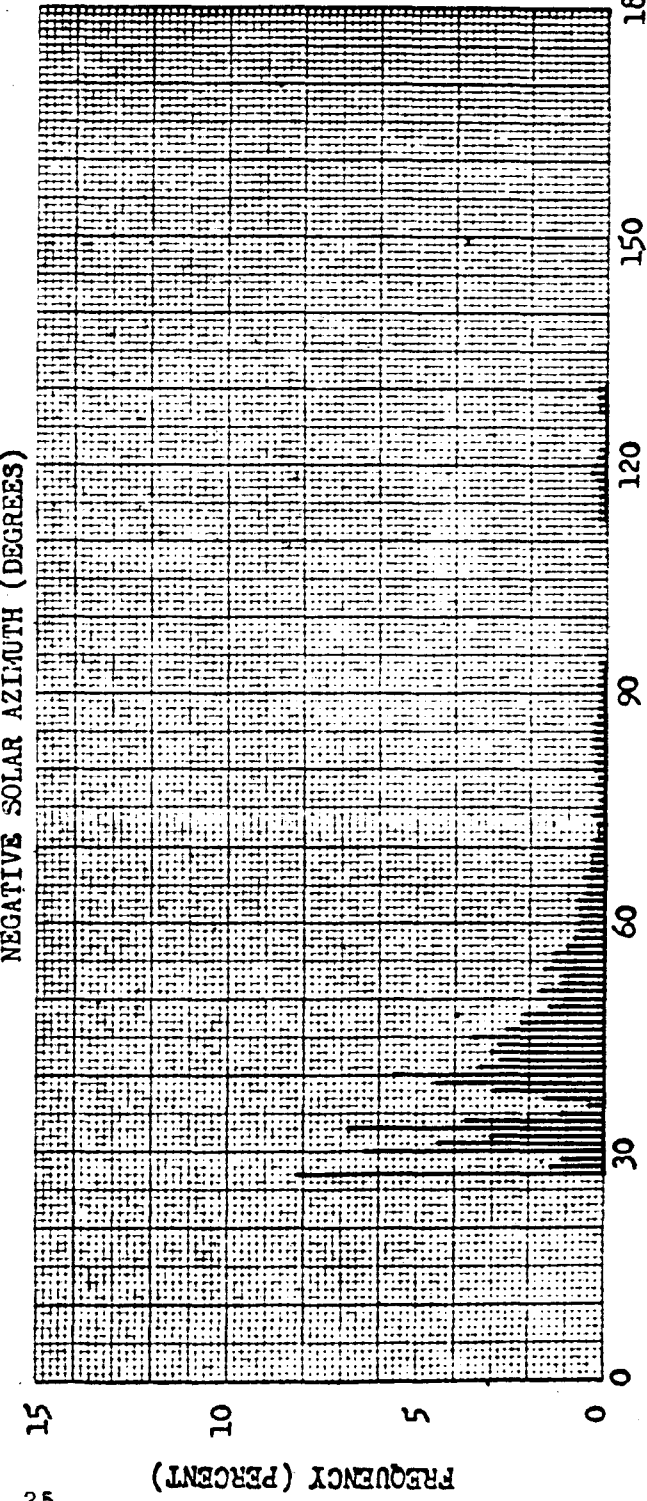

180

150

120

90

60

30

0

FREQUENCY (PERCENT)

55

Inclination: 75°

SIGN NOTATION

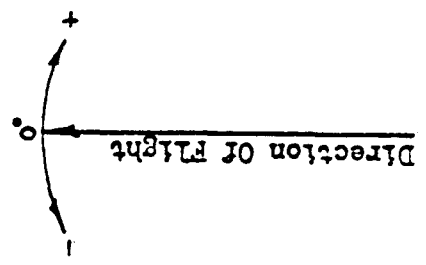

POSITIVE SOLAR AZIMUTH (DEGREES)

TOP SECRET C
NO.

SOLAR ELEVATION FREQUENCY DISTRIBUTION

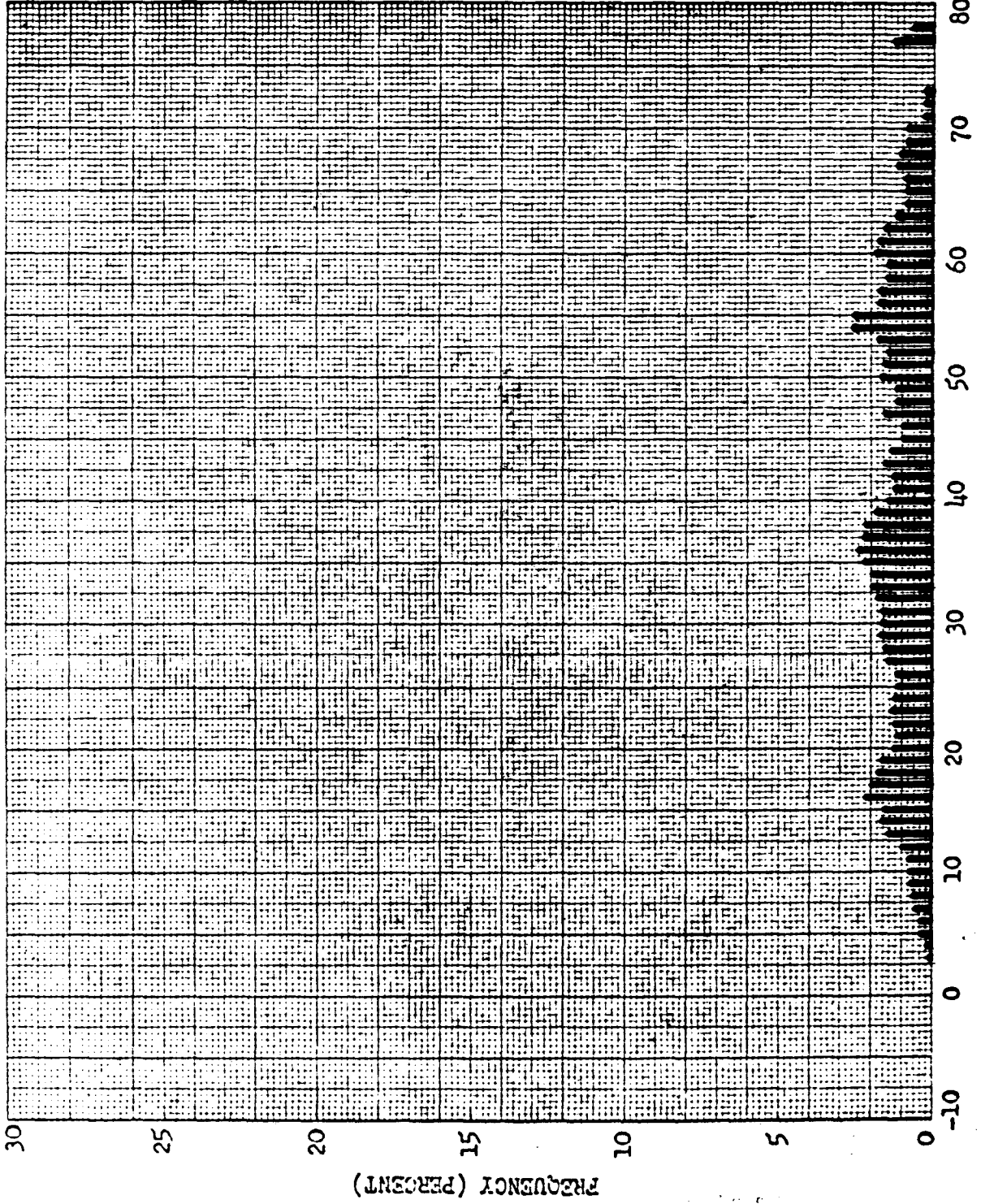

Mission No: 1030-2
Payload No: J-29
Camera No: 182
Launch Date: 3/9/66
Launch Time: 2202 Z
Inclination: 75°

TOP SECRET C

Figure 8-3

NO. [REDACTED]

SOLAR AZIMUTH FREQUENCY DISTRIBUTION

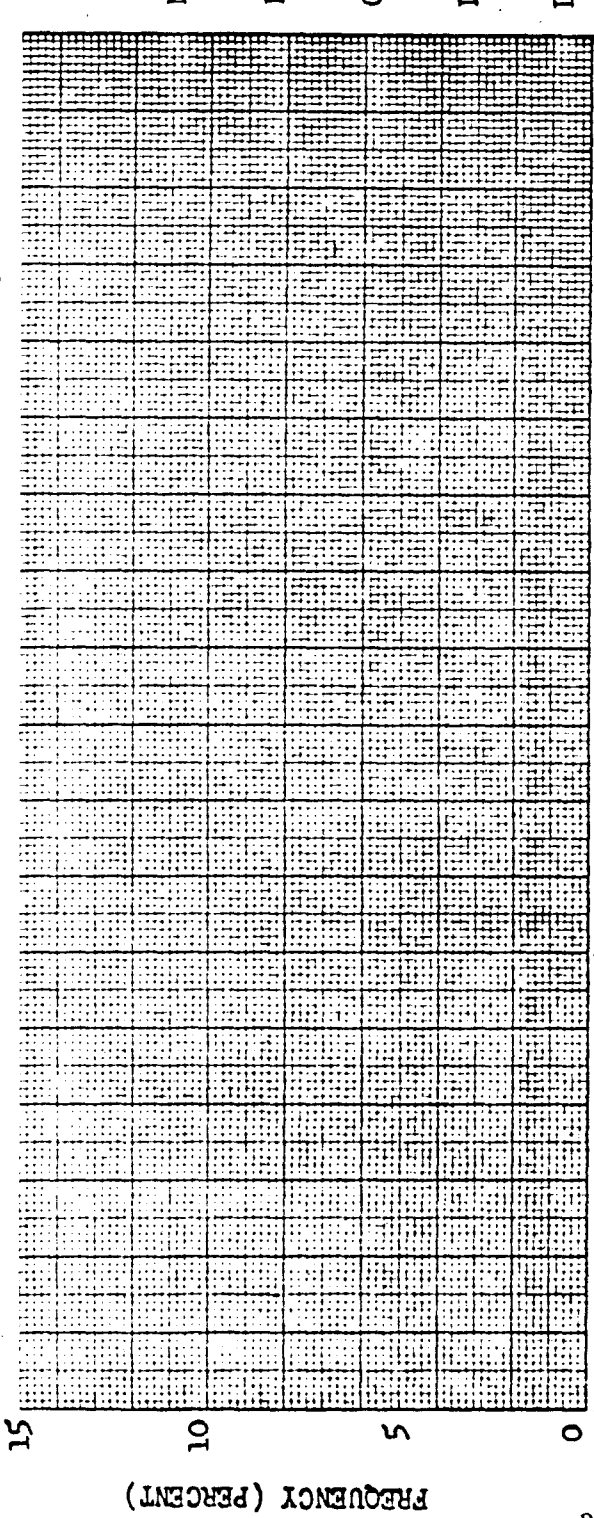

37

Mission No: 1030-2
Payload No: J-29
Camera No: 182
Launch Date: 3/9/66
Launch Time: 2202 Z

Inclination: 75°

SIGN NOTATION

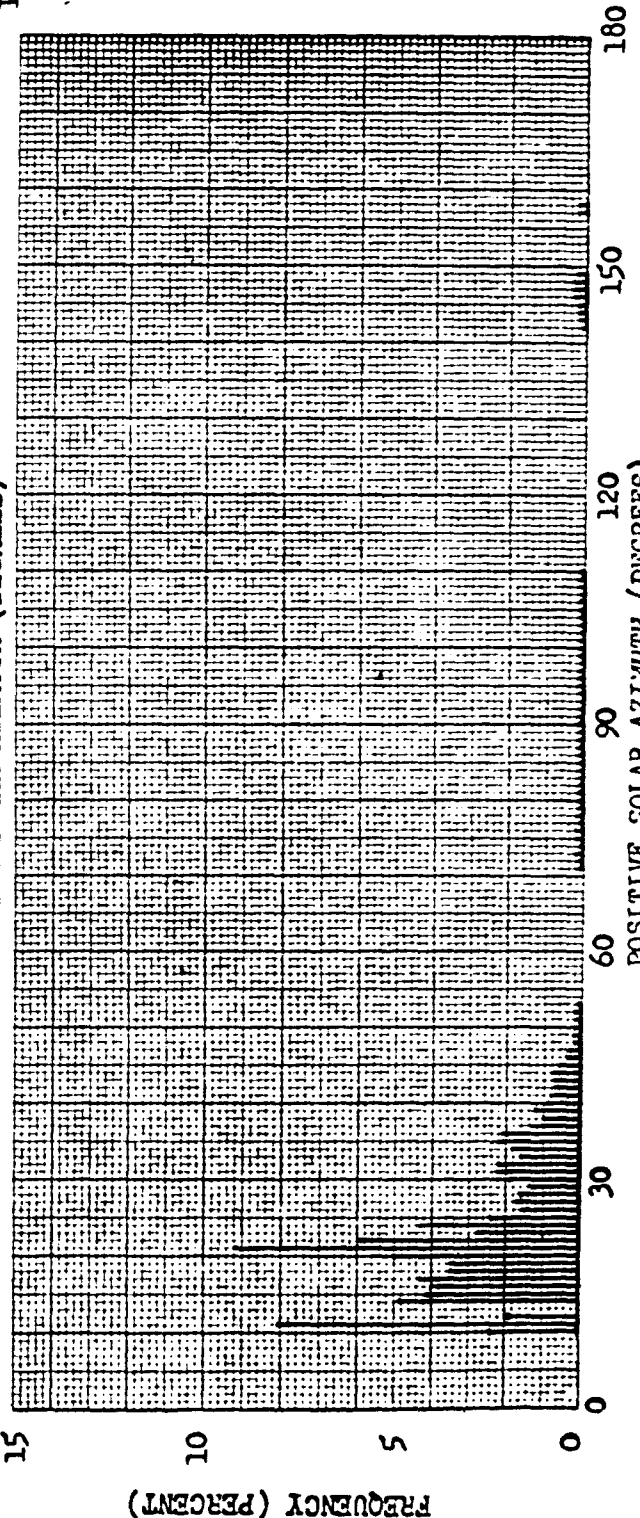
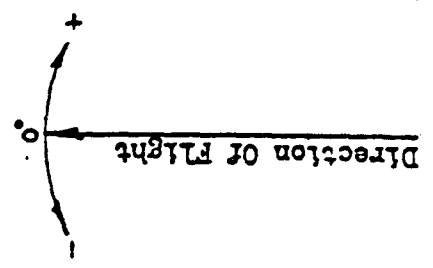

TOP SECRET (C) [REDACTED]

Figure B-4

[REDACTED]

EXPOSURE POINTS

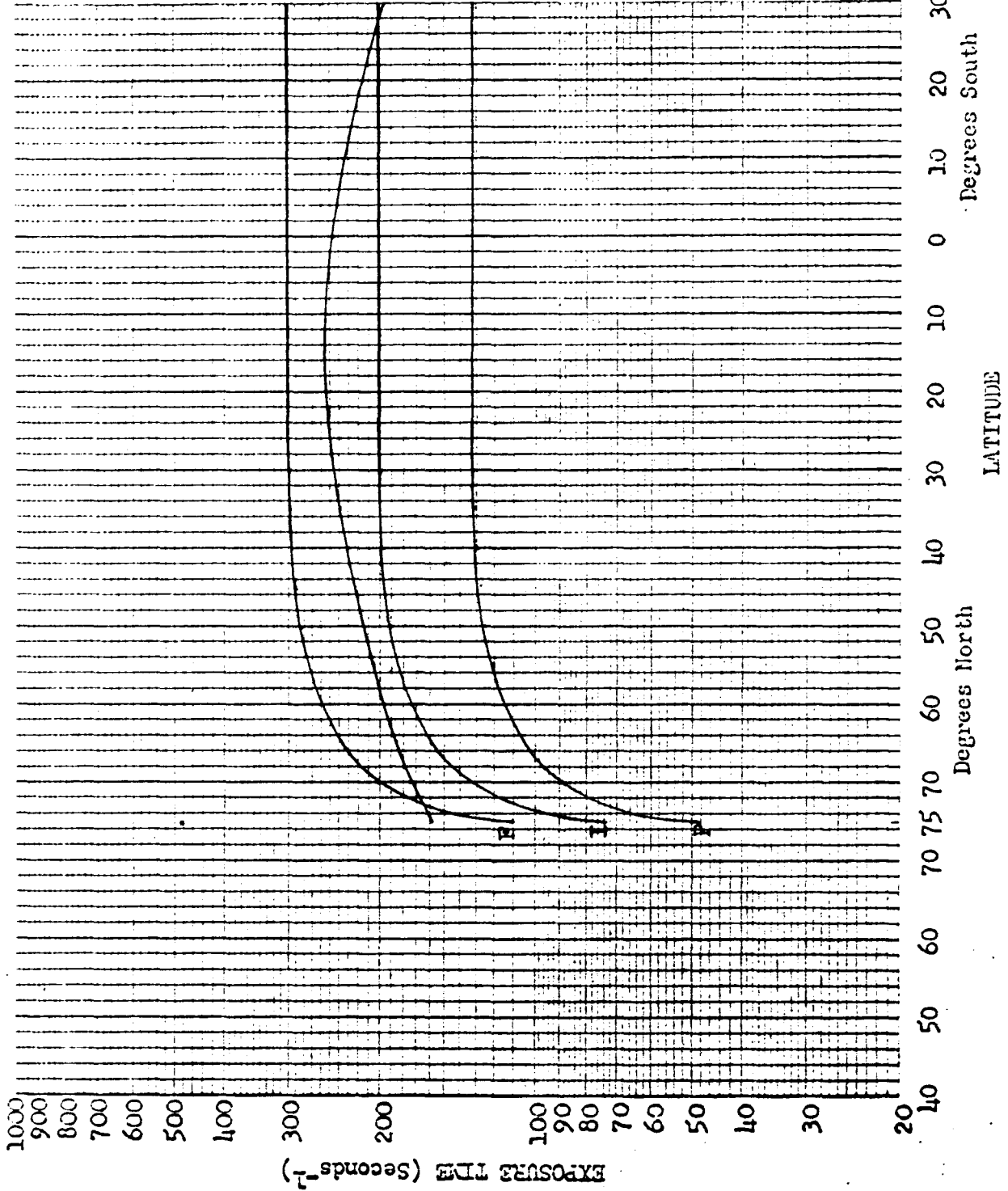

Mission No: 1030
Payload No: J-29
Camera No: 132
Pass No: 8
Launch Date: 3/9/60
Launch Time: 2202 Z
Slit Width: .275
Filter Type: Wratten 25
Film Type: 3104

[REDACTED]

[REDACTED]

EXPOSURE POINTS

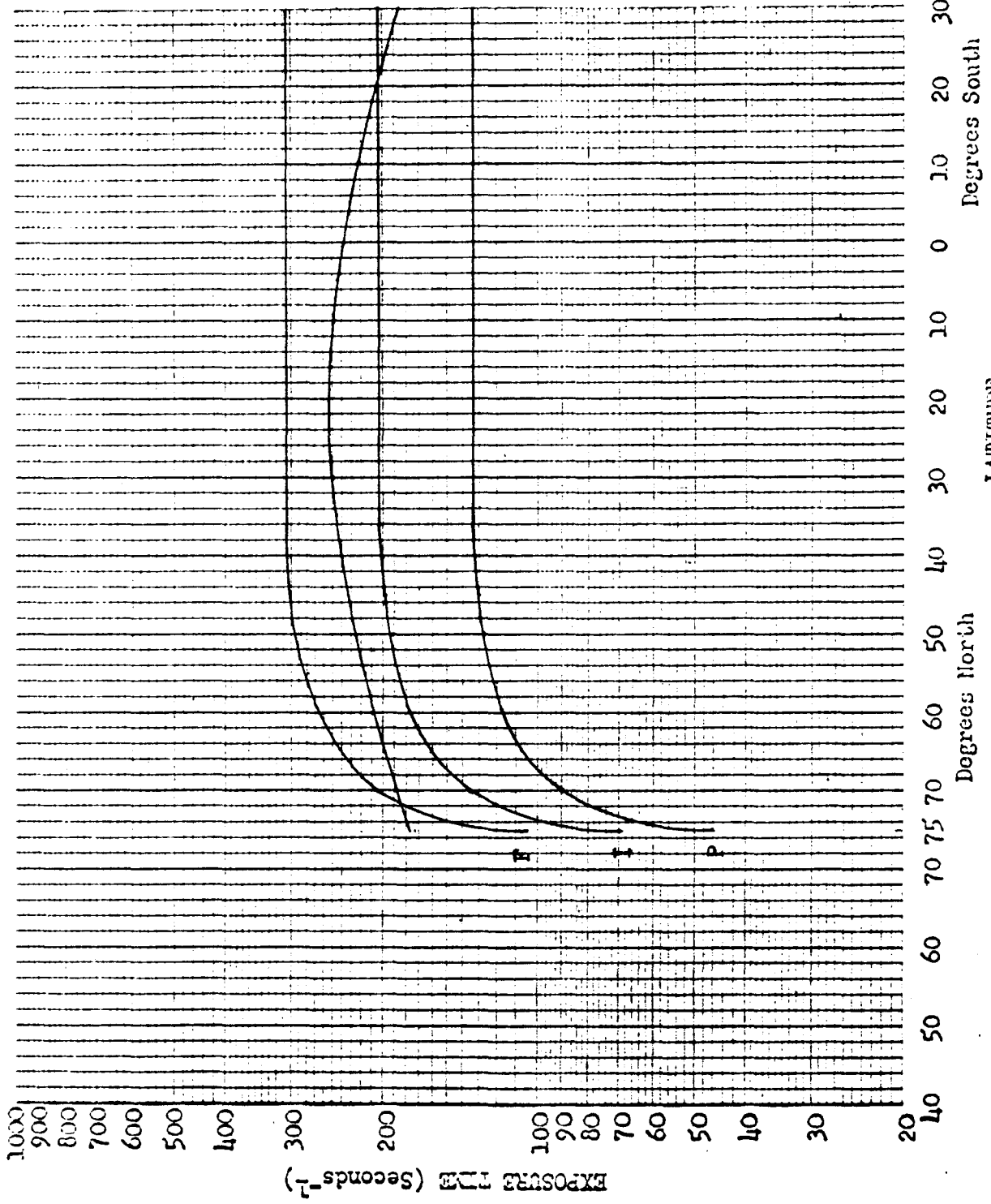

Mission No: 1030
Payload No: J-29
Camera No: 182
Pass No: 56
Launch Date: 3/9/66
Launch Time: 2202 Z
Slit Width: .275
Filter Type: Wratten 25
Film Type: 3404

~~TOP SECRET~~

Figure 5

[REDACTED]

EXPOSURE POINTS

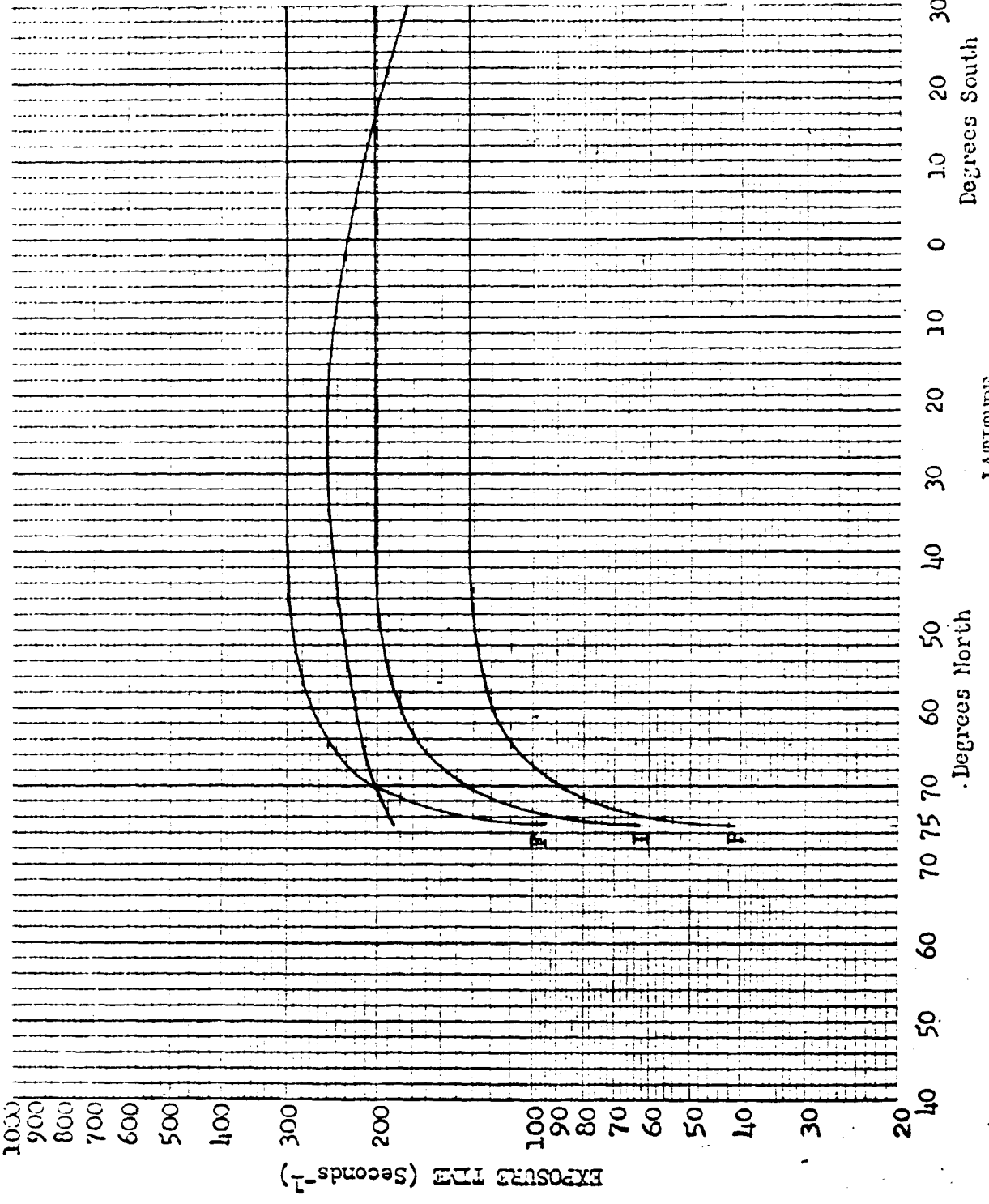

Mission No: 1030
Payload No: J-29
Camera No: 182
Pass No: 103
Launch Date: 3/9/66
Launch Time: 2202 Z
Slit Width: .275
Filter Type: Wratten 25
Film Type: 3404

LATITUDE

TOP SECRET

Figure 10

[REDACTED]

EXPOSURE PLOT

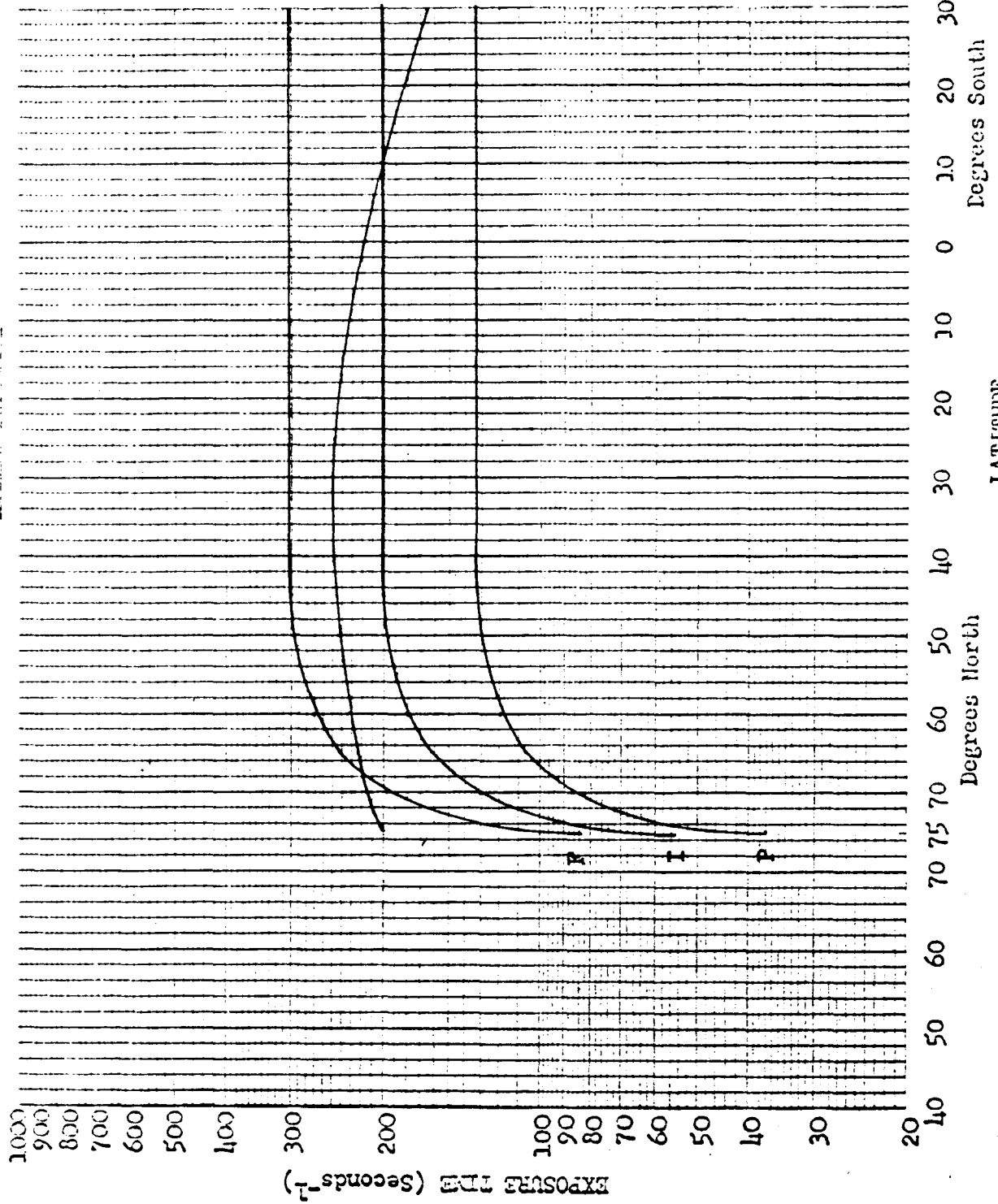

Mission No: 130
Payload No: 6-29
Camera No: 132
Pass No: 151
Launch Date: 3/9/66
Launch Time: 2202 Z
Slit Width: .275
Filter Type: Wratten 25
Film Type: 3104

LATITUDE

TOP SECRET

Figure 1-1

[REDACTED]

EXPOSURE POINTS

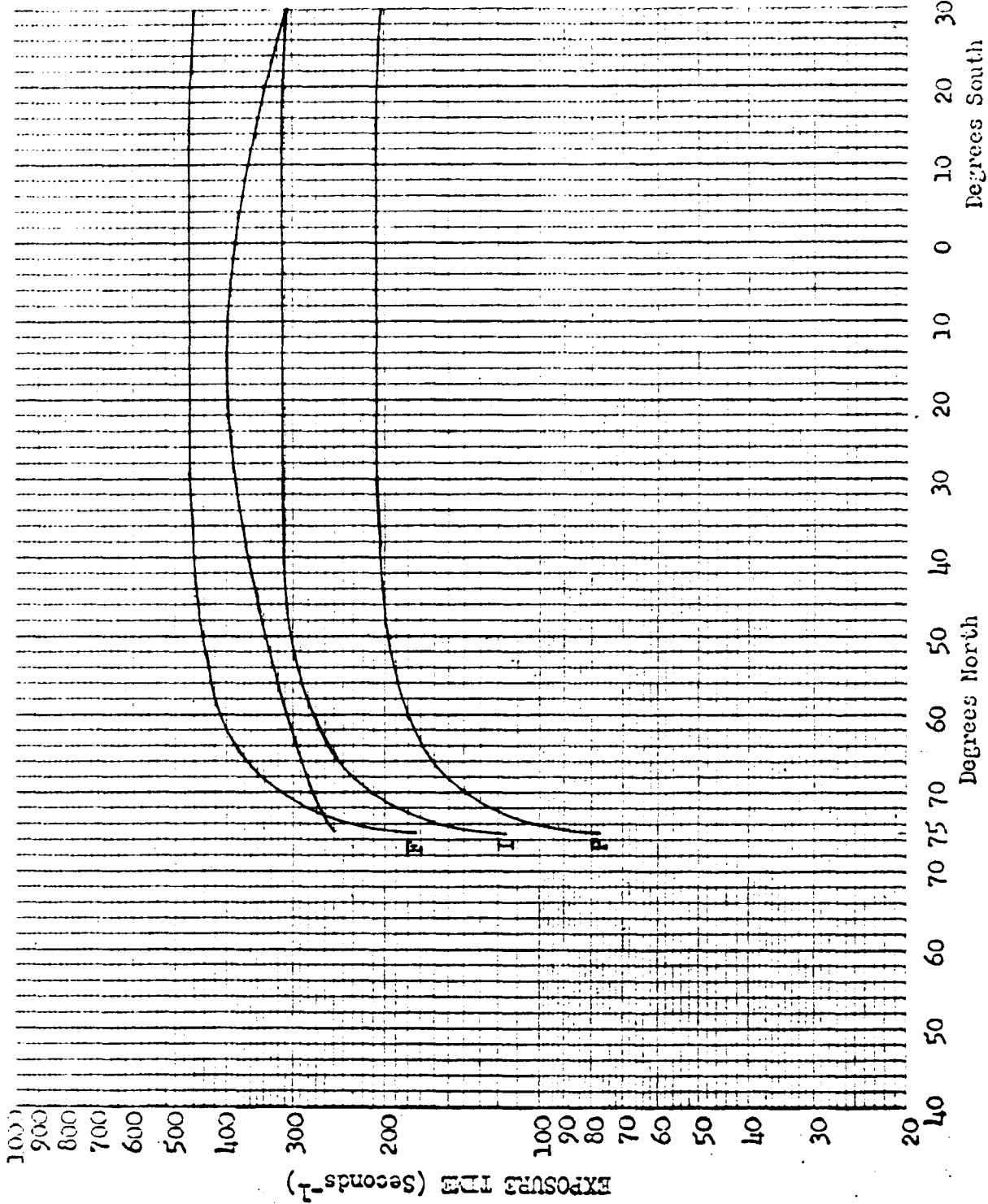

Mission No: 1030

Payload No: 1-29

Camera No: 183

Pass No: 5

Launch Date: 3/9/60

Launch Time: 2202 Z

Slit Width: .175

Film No: Wratten 21

Film Type: 3104

LATITUDE

Degrees South

Degrees North

[REDACTED]

[REDACTED]

115

[REDACTED]

EXPOSURE POINTS

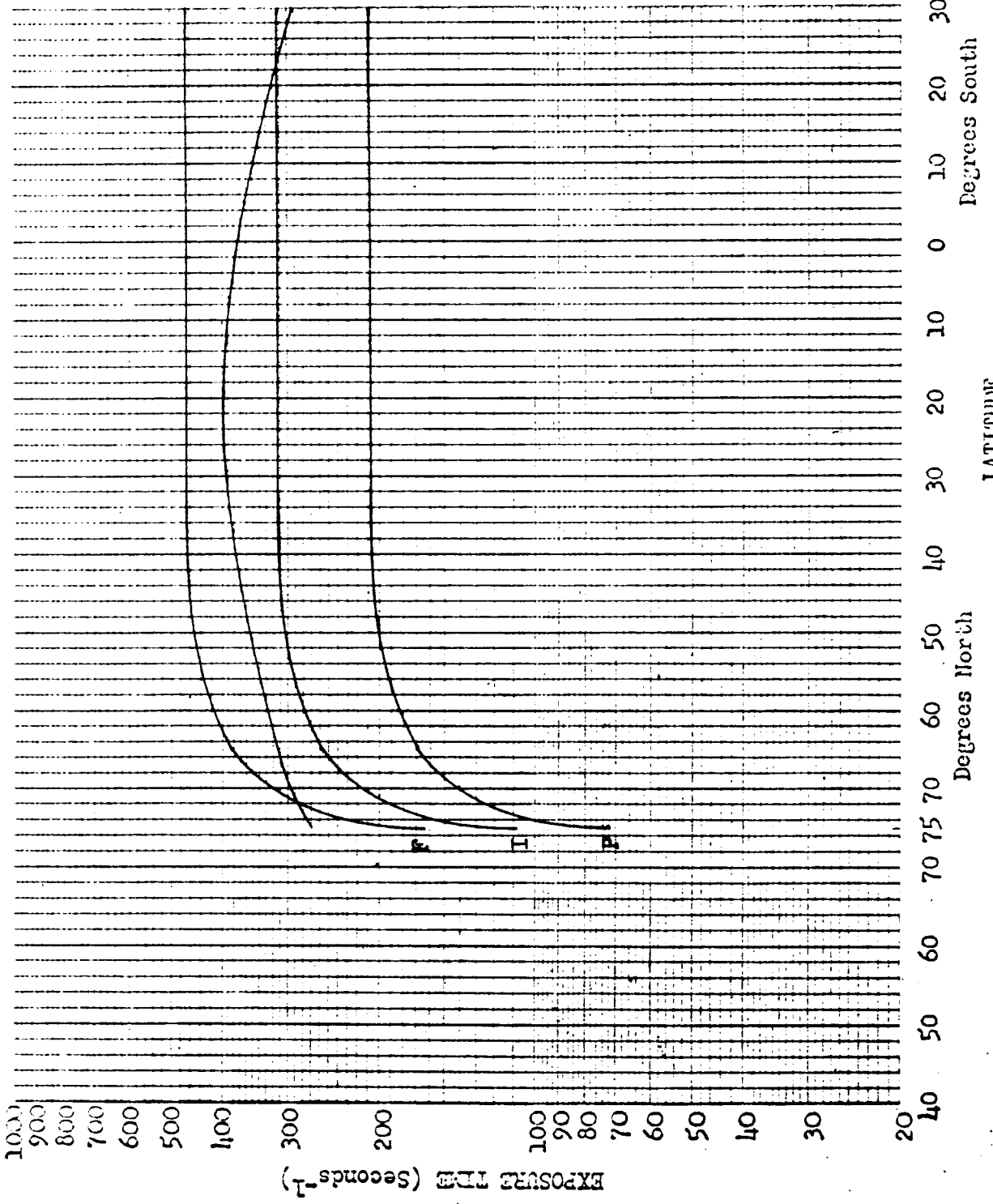

Mission No: 1030
Payload No: J-29
Camera No: 163
Roll No: 56
Launch Date: 3/9/56
Launch Time: 2202 Z
Slit Width: .175
Filter type: Wratten 21
Film Type: 3104

NO. [REDACTED]

EXPOSURE CURVES

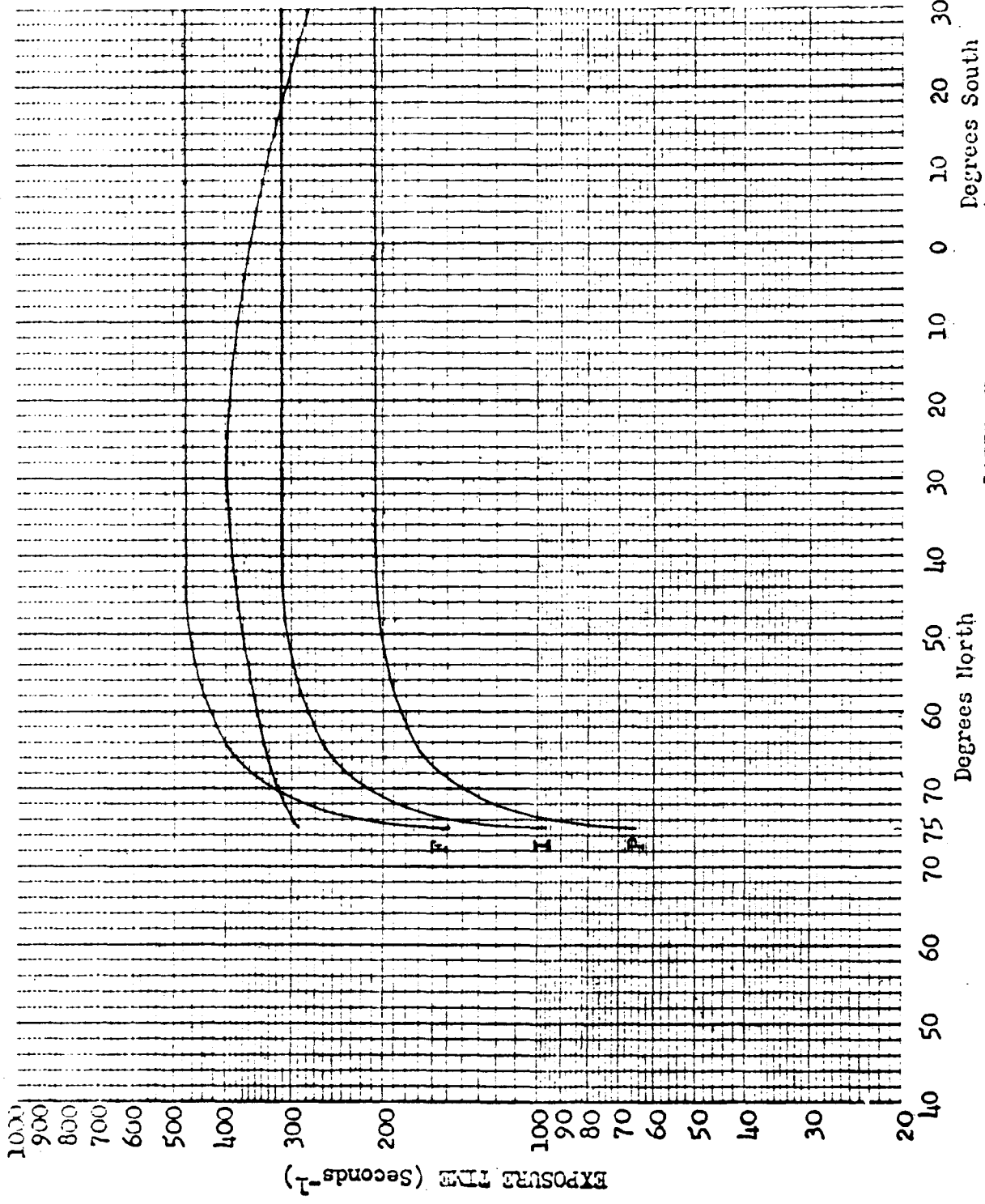

Mission No: 1030
 Payload No: J-29
 Camera No: 183
 Pass No: 103
 Launch Date: 3/9/66
 Launch Time: 2202 Z
 Slit Width: .175
 Filter Type: Wratten 21
 Film Type: 3104

TOP SECRET C

Figure 8-11

~~TOP SECRET C~~
NOV. [REDACTED]

EXPOSURE CURVE

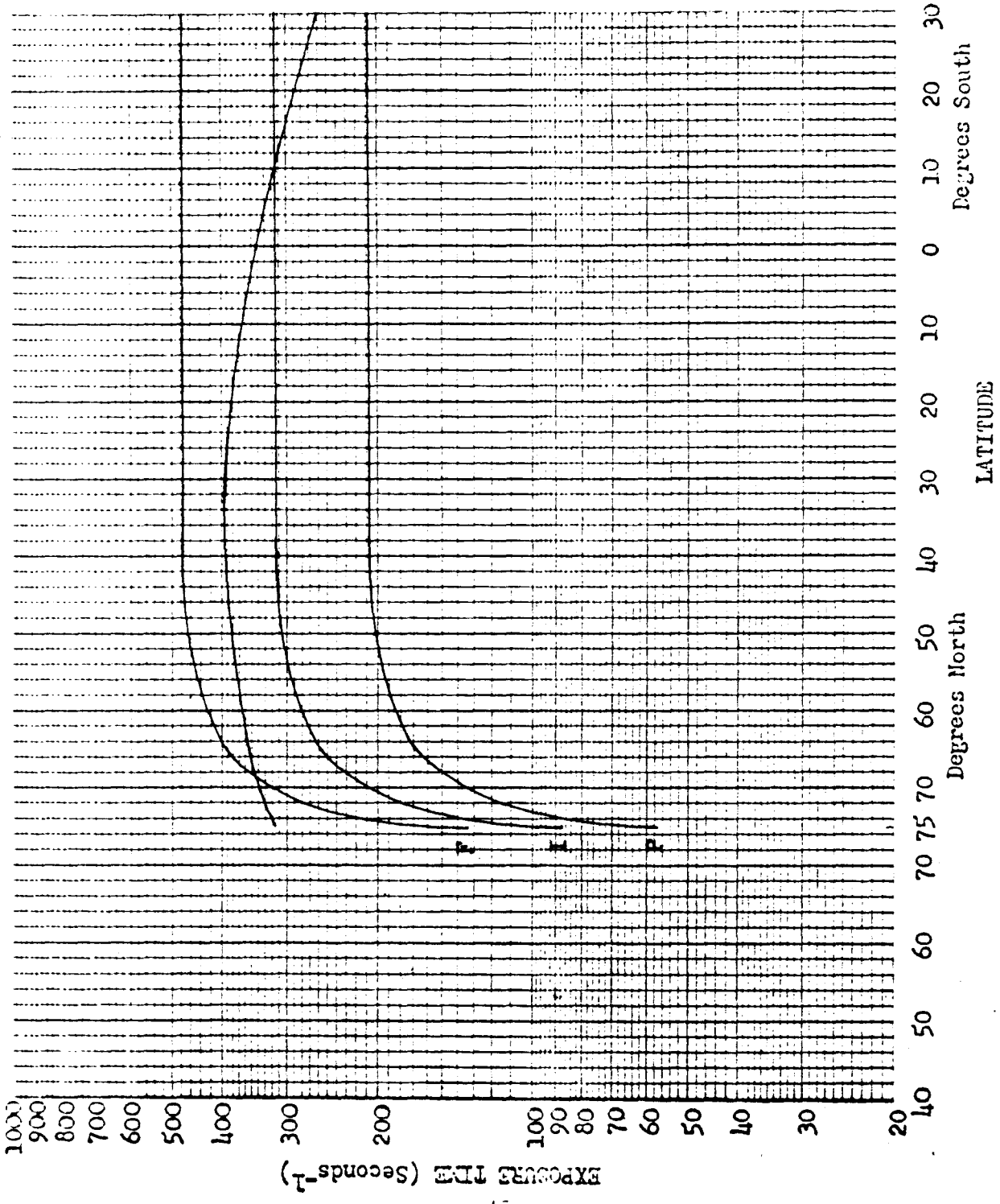

Mission No: 1039
Payload No: J-29
Camera No: 153
Pass No: 151
Launch Date: 3/9/66
Launch Time: 2202 Z
Slit Width: .175
Filter Type: Wratten 21
Film Type: 3404

~~TOP SECRET C~~

Figure 8-12

SECTION 9

DIFFUSE DENSITY MEASUREMENTS

The diffuse density measurements made by AFSPPF were computer sorted at A/P to permit analysis of the density ranges encountered at the three processing levels. A study of sorting techniques showed that no absolute method was available to separate the density values as the accuracy of the Processing History published by [redacted] appears rather low and processing transition phases are not accounted for. The sorting technique selected uses the base plus fog density values where measurements up to 0.09 density are considered as having received Primary processing, 0.10 to 0.17 as Intermediate and above 0.17 density as Full. The percentage of original negative that was processed at each level, based on the computer sort, is tabulated below with the predicted and reported processing percentages.

<u>Mission</u>	<u>Camera</u>		<u>Primary</u>	<u>Intermediate</u>	<u>Full</u>
1030-1	FWD	Predicted	0%	58	42
		Reported	3	31.7	65.3
		Computed	0.8	51.7	47.5
1030-1	AFT	Predicted	0	53	47
		Reported	0.2	45.6	54.2
		Computed	0	71	29
1030-2	FWD	Predicted	1	42	57
		Reported	0.1	52.5	47.4
		Computed	0	70	30
1030-2	AFT	Predicted	1	23	76
		Reported	0.2	28.3	71.5
		Computed	0	30	70

The tabulations of density frequency distributions for Missions 1030-1 and 1030-2 are included in Appendix A, Table A-1 thru A-4. The graphical presentation of the density distribution are computer plotted in Appendix A Figures A-1 thru A-39.

A summary of the processing and exposure analysis is shown in Table 9-1. The terrain D-Min criteria, (range) for proper exposure and processing is 0.40 to 0.90 density units. The area measured for D-Min is selected subjectively and is not necessarily the absolute D-Min in the photography.

A density range chart, Figure 9-1 is included in this report. This type of chart for missions 1004 to 1031 is included in the A/P Final Report for Mission 1031.

These charts are produced from the same density measurements previously mentioned in this section. The computer produced the mean, median and range figures for the various processing levels used. The chart includes the number of frames (samples) in which the density measurements were made. These measurements are made on approximately every tenth frame throughout the mission.

J MISSION DENSITY RANGES

~~TOP SECRET~~
[REDACTED]

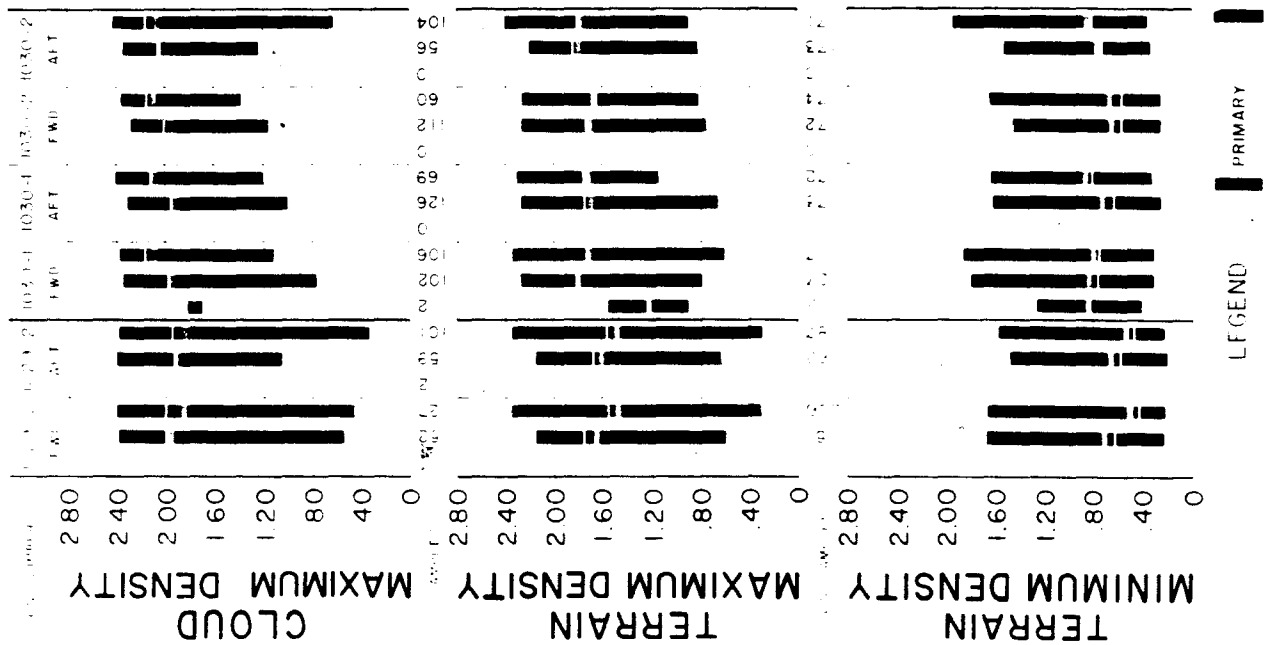

~~TOP SECRET~~

FIG 9-1

SECRET



MISSION 100-1		INSTN - FRWD		8/25/66 PROCESSING AND EXPOSURE ANALYSIS		
PROCESS LEVEL	SAMPLE SIZE	UNDER EXPOSED	UNDER PROCESSED	CORRECT EXP+PROC	OVER PROCESSED	OVER EXPOSED
PRIMARY	172	1 PC	7 PC	50 PC	0 PC	50 PC
INTERMEDIATE	173	0 PC	6 PC	59 PC	27 PC	8 PC
FIELD	117	3 PC	7 PC	62 PC	27 PC	1 PC
ALL LEVELS	244	4 PC	3 PC	61 PC	29 PC	5 PC

MISSION 100-1		INSTN - AFT		8/25/66 PROCESSING AND EXPOSURE ANALYSIS		
PROCESS LEVEL	SAMPLE SIZE	UNDER EXPOSED	UNDER PROCESSED	CORRECT EXP+PROC	OVER PROCESSED	OVER EXPOSED
PRIMARY	172	0 PC	0 PC	0 PC	0 PC	0 PC
INTERMEDIATE	173	0 PC	12 PC	65 PC	17 PC	6 PC
FIELD	77	3 PC	0 PC	61 PC	36 PC	0 PC
ALL LEVELS	245	1 PC	9 PC	64 PC	22 PC	4 PC

MISSION 100-2		INSTN - FRWD		8/25/66 PROCESSING AND EXPOSURE ANALYSIS		
PROCESS LEVEL	SAMPLE SIZE	UNDER EXPOSED	UNDER PROCESSED	CORRECT EXP+PROC	OVER PROCESSED	OVER EXPOSED
PRIMARY	172	0 PC	0 PC	0 PC	0 PC	0 PC
INTERMEDIATE	173	0 PC	13 PC	73 PC	12 PC	3 PC
FIELD	117	15 PC	0 PC	65 PC	18 PC	0 PC
ALL LEVELS	245	9 PC	9 PC	71 PC	13 PC	2 PC

MISSION 100-2		INSTN - AFT		8/25/66 PROCESSING AND EXPOSURE ANALYSIS		
PROCESS LEVEL	SAMPLE SIZE	UNDER EXPOSED	UNDER PROCESSED	CORRECT EXP+PROC	OVER PROCESSED	OVER EXPOSED
PRIMARY	172	0 PC	0 PC	0 PC	0 PC	0 PC
INTERMEDIATE	173	0 PC	1 PC	75 PC	19 PC	4 PC
FIELD	117	0 PC	0 PC	63 PC	35 PC	1 PC
ALL LEVELS	245	0 PC	0 PC	66 PC	30 PC	2 PC

PROCESS LEVEL	SAMPLE SIZE	UNDER EXPOSED	UNDER PROCESSED	CORRECT EXP+PROC	OVER PROCESSED	OVER EXPOSED
PRIMARY	0.01-0.09	0.01-0.13	0.14-0.39	0.40-0.90	-----	0.91 AND UP
INTERMEDIATE	0.10-0.17	0.01-0.20	0.21-0.39	0.40-0.90	0.91-1.34	1.35 AND UP
FIELD	0.18 AND UP	0.01-0.39	-----	0.40-0.90	0.91-1.69	1.70 AND UP

SECRET



Table 9-1

SECTION 10

PERFORMANCE MEASUREMENTS

The photography acquired by both panoramic cameras during Missions 1030-1 and 1030-2 received a MIP rating of 85. A summary is tabulated below of the MTF/AIM resolution values measured by AFSPPF and [REDACTED]. The microdensitometer slit used by AFSPPF and [REDACTED] was 80 microns by one micron.

<u>Mission</u>	<u>Camera</u>	<u>AFSPPF</u>	[REDACTED]
1030-1	FWD	81	66
1030-1	AFT	74	77
1030-2	FWD	73	71
1030-2	AFT	86	71

The details of the measurement and computing techniques, targets measured and target locations are fully reported in the evaluation report published by AFSPPF and are not normally included in this report.

SECTION 11

OBSERVED DATA

Mission 1030 contained an unusually high percentage of photography that was degraded by atmospheric conditions, the PEIR report states that for Mission 1030-1 only 2% was clear terrain, and Mission 1030-2 contained 11% clear terrain. Consequently, only a very small amount of photography from engineering operations is suitable for evaluating the system performance capability.

Pass D47 covered Indian Springs and Pahrump Fixed CORN targets. Indian Springs had solid cloud cover. Pahrump was degraded by thin clouds or haze, but the high contrast fixed target was read to 12 feet ground resolution. A mobile T Bar Target of low contrast was deployed near the fixed target. The largest group (16 feet) could not be resolved. Obviously, the system capability is much better than shown under this atmospheric condition.

The other 2 resolution targets photographed on this mission were even less useful. The Fort Huachuca target on pass D31 was in the bonus area and out of focus. A mobil medium T-Bar target was deployed at Lompoc, California for pass D126. This target appeared 2 inches from the end of the format and thus suffered loss of scale. The forward camera resolved 16 feet on the ground and the aft camera resolved 12 feet.

Pass D126 did contain a few square miles of clear terrain around Ventura, California with no detectable haze. At a sewage treatment plant the catwalks and spray arms on the clarifier tanks were detected by both cameras, representing a detection capability of 5 feet. A few miles away, at Oxnard AFB, the 3 foot spaces of the runway threshold markers could not be seen, in spite of a 15:1 aspect ratio.

The only conclusion that can be drawn from the foregoing is that this particular system was capable of resolving less than 12 feet on the ground, but probably could not resolve 6 feet.

SECTION 12

MISSION 1030-1 STELLAR-INDEX CAMERA

A. COMPONENT ASSIGNMENT

<u>Component</u>	<u>Serial Number</u>
Camera	D-94
Index Reseau	100
Stellar Reseau	107

B. CAMERA DATA AND FLIGHT SETTINGS

Stellar Camera:

Lens	85 mm f/1.8
Exposure Time	2 seconds
Filter Type	None
Film Type	Eastman Type 3401

Index Camera:

Lens	38 mm f/4.5
Exposure Time	1/500 second
Filter Type	Wratten 21
Film Type	Eastman Type 3400

C. POST FLIGHT PERFORMANCE EVALUATION

The -1 mission instruments each produced 422 frames of good quality photography. Plus density streaks, multidirectional, appeared intermittently through frame 78 of the stellar material. To determine the source of these particles would be difficult and since they have a minimal effect on data reduction, there will be no further action taken.

SECTION 13

MISSION 1030-2 STELLAR-INDEX CAMERA

A. COMPONENT ASSIGNMENT

<u>Component</u>	<u>Serial Number</u>
Camera	D-82
Index Reseau	195
Stellar Reseau	102

B. CAMERA DATA AND FLIGHT SETTINGS

Stellar Camera:

Lens	85 mm f/1.8
Exposure Time	2 seconds
Filter Type	None
Film Type	Eastman Type 3401

Index Camera:

Lens	38 mm f/4.5
Exposure Time	1/500 second
Filter Type	Wratten 21
Film Type	Eastman Type 3400

C. POST FLIGHT EVALUATION

The -2 mission instruments each produced 444 frames of good quality for data reduction.

In many target areas there was a severe haze layer that drastically reduced contrast and image quality. An analysis of the index material shows that only 15% of the -1 mission and 17% of the -2 mission had clear weather (10% or less cloud cover).

SECTION 14

VEHICLE ATTITUDE

The vehicle attitude errors for both Mission 1030-1 and 1030-2 were derived from the reduction of the Stellar camera photography. This attitude data is supplied to A/P by NPIC.

The attitude errors for each frame and the attitude control rates are calculated at the A/P computer facility. The computer also plots the frequency distribution of the rates and errors. Figures 14-1 through 14-6 show these distributions for Mission 1030-1 and Figures 14-7 through 14-12 for Mission 1030-2.

The summary table below lists the maximum attitude errors and rates that were experienced during 90% of the FWD photographic operations, excluding the first six frames of each operation, and the total range of the errors and rates.

<u>Value</u>	<u>Mission 1030-1</u>		<u>Mission 1030-2</u>	
	<u>90%</u>	<u>Range</u>	<u>90%</u>	<u>Range</u>
Pitch Error ($^{\circ}$)	0.67	-0.38 to +0.96	0.70	-0.06 to +1.0
Roll Error ($^{\circ}$)	0.25	-0.26 to +0.80	0.27	-0.35 to +1.05
Yaw Error ($^{\circ}$)	0.89	-1.30 to +0.90	0.87	-1.35 to +1.05
Pitch Rate ($^{\circ}$ /hr.)	29.63	-85 to +85	28.38	-56 to +76
Roll Rate ($^{\circ}$ /hr.)	22.70	-65 to +75	22.66	-90 to +80
Yaw Rate ($^{\circ}$ /hr.)	36.09	-50 to +85	36.29	-50 to 62

J-29 A-PUCKET FORWARD INSTRUME FRAMES 1-6 OF EACH OP OMITTED 90 PERCENT = .0.67

Y PITCH ANGLE ERROR - DEGREES (X) VERSUS FREQUENCY - PERCENT (Y)

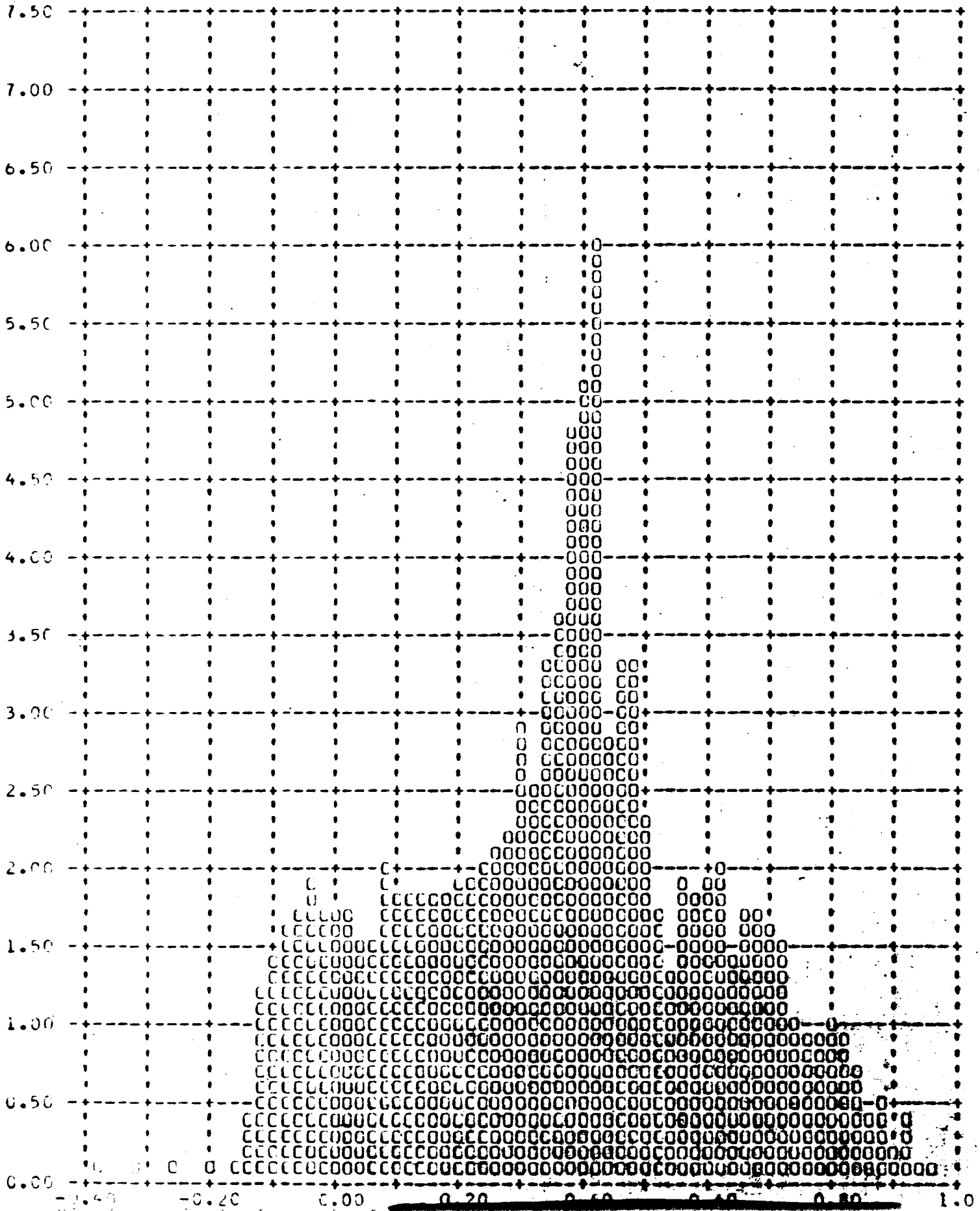

-29 A-PACKET FORWARD INSTRUME FRAMES 1-6 OF EACH OP OMITTED 90 PERCENT = 0.25

Y ROLL ANGLE ERROR - DEGREES (X) VERSUS FREQUENCY - PERCENT (Y)

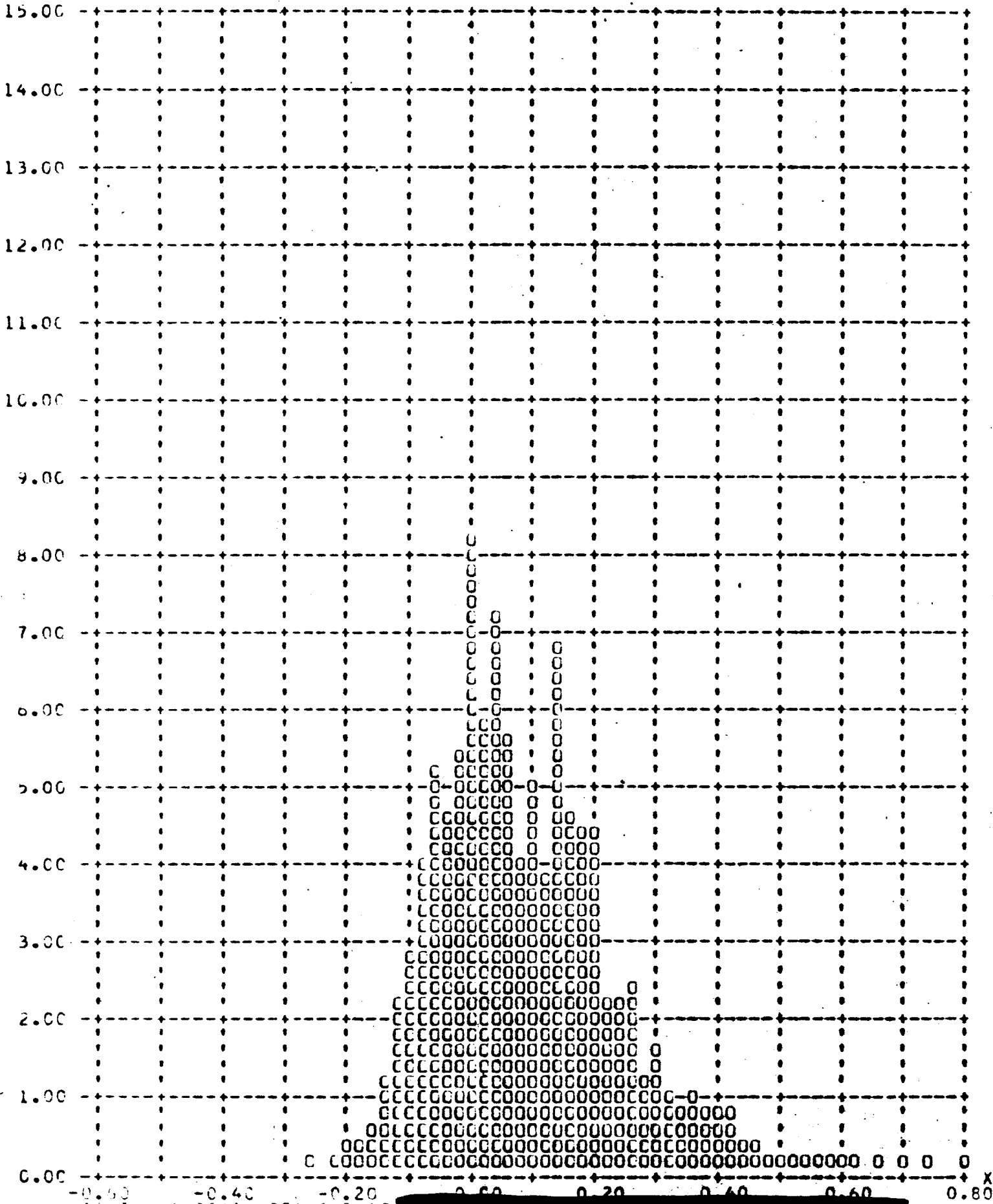

1-29 A-BUCKET FORWARD INSTRUMENT FRAMES 1-6 OF EACH OP OMITTED 90 PERCENT = 0.89

Y YAW ANGLE ERROR - DEGREES (X) VERSUS FREQUENCY - PERCENT (Y)

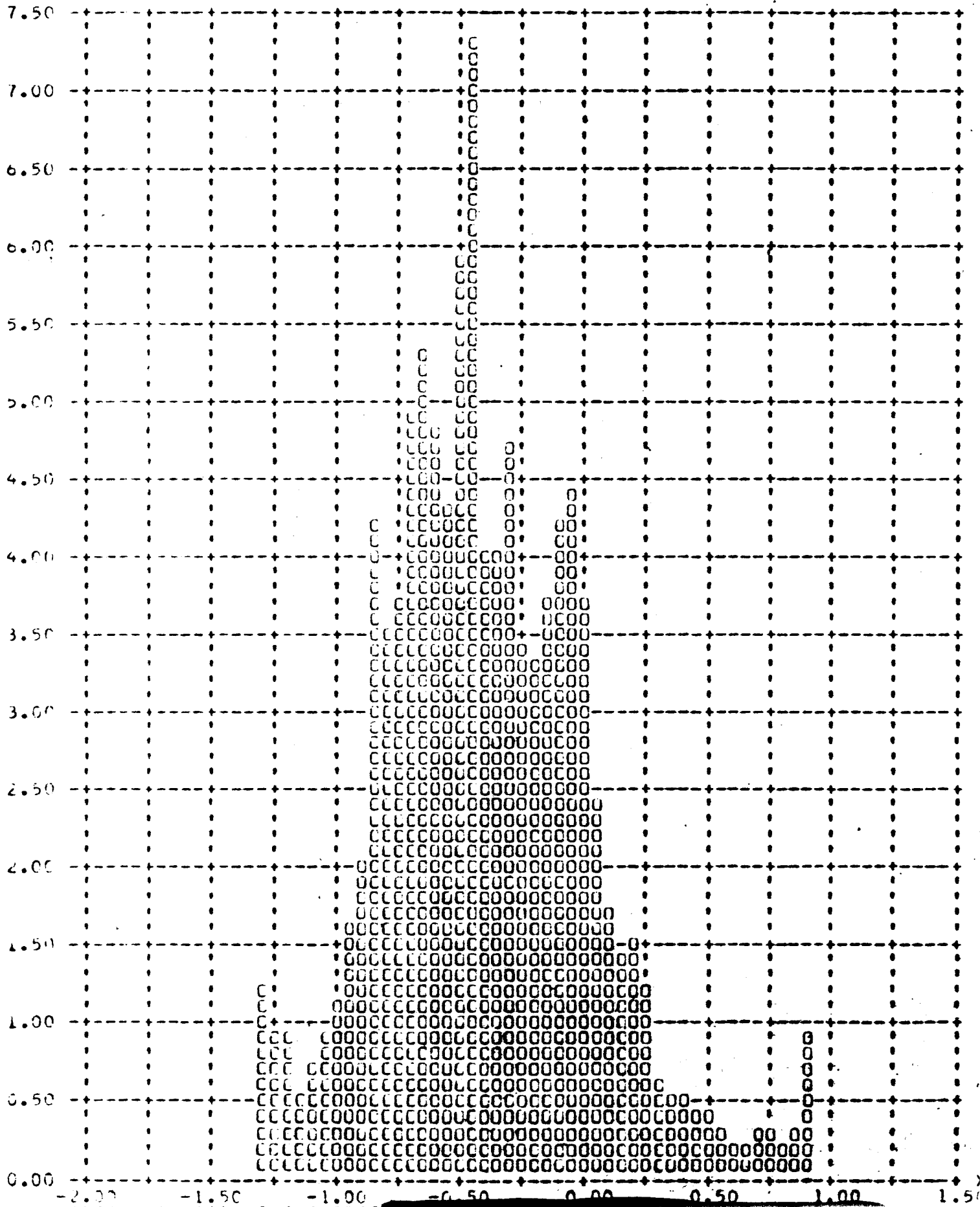



J-29 A-BUCKET FORWARD INSTRUMT FRAMES 1-6 OF EACH OP OMITTED 90 PERCENT = 29.6

Y PITCH RATE ERROR - DEG/HOUR (X) VERSUS FREQUENCY - PERCENT (Y)

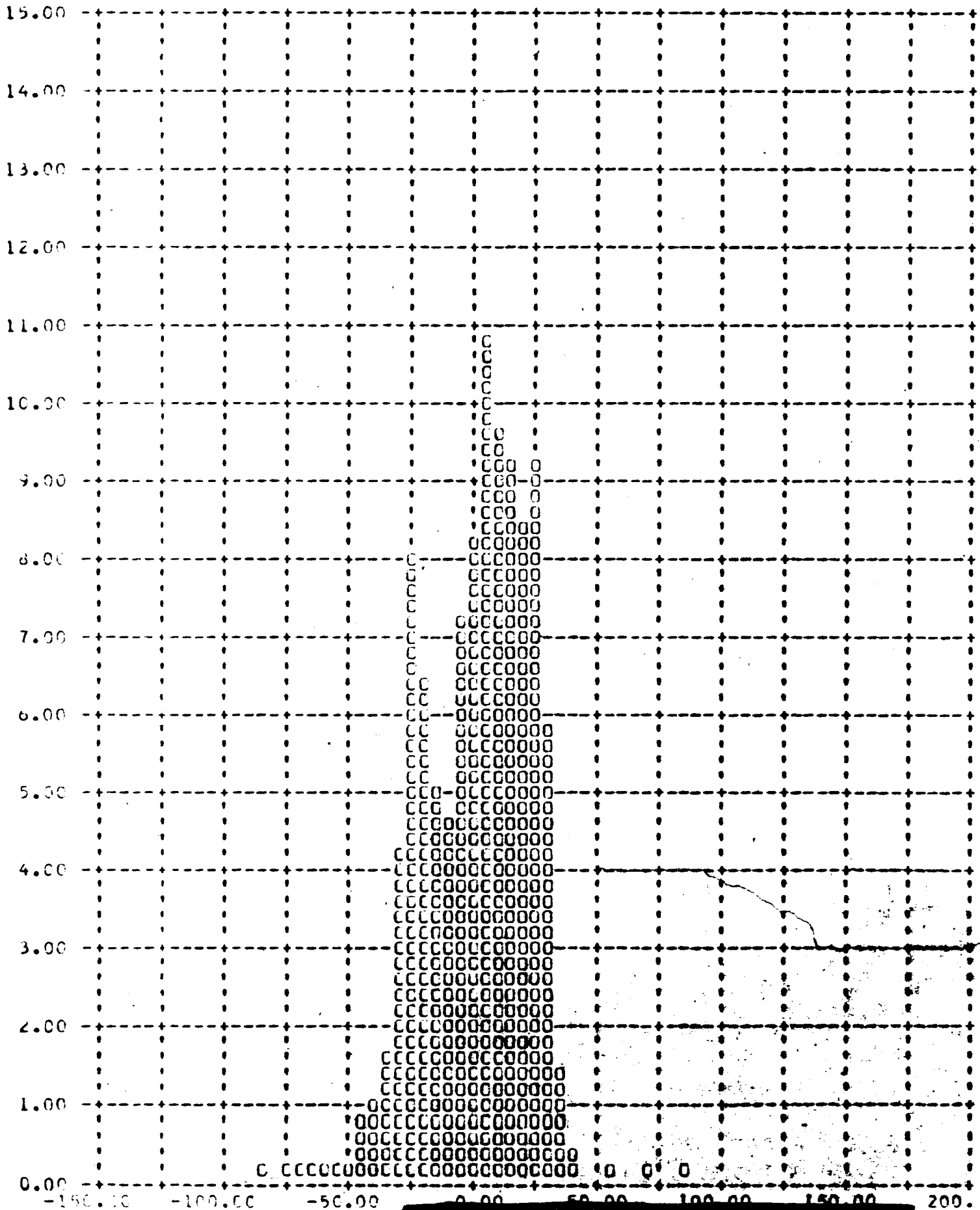

I-29 A-POCKET FORWARD INSTRUMF FRAMES 1-6 OF EACH OP OMITTED 90 PERCENT = 22.70

Y ROLL RATE ERROR - DEG/HOUR (X) VERSUS FREQUENCY - PERCENT (Y)

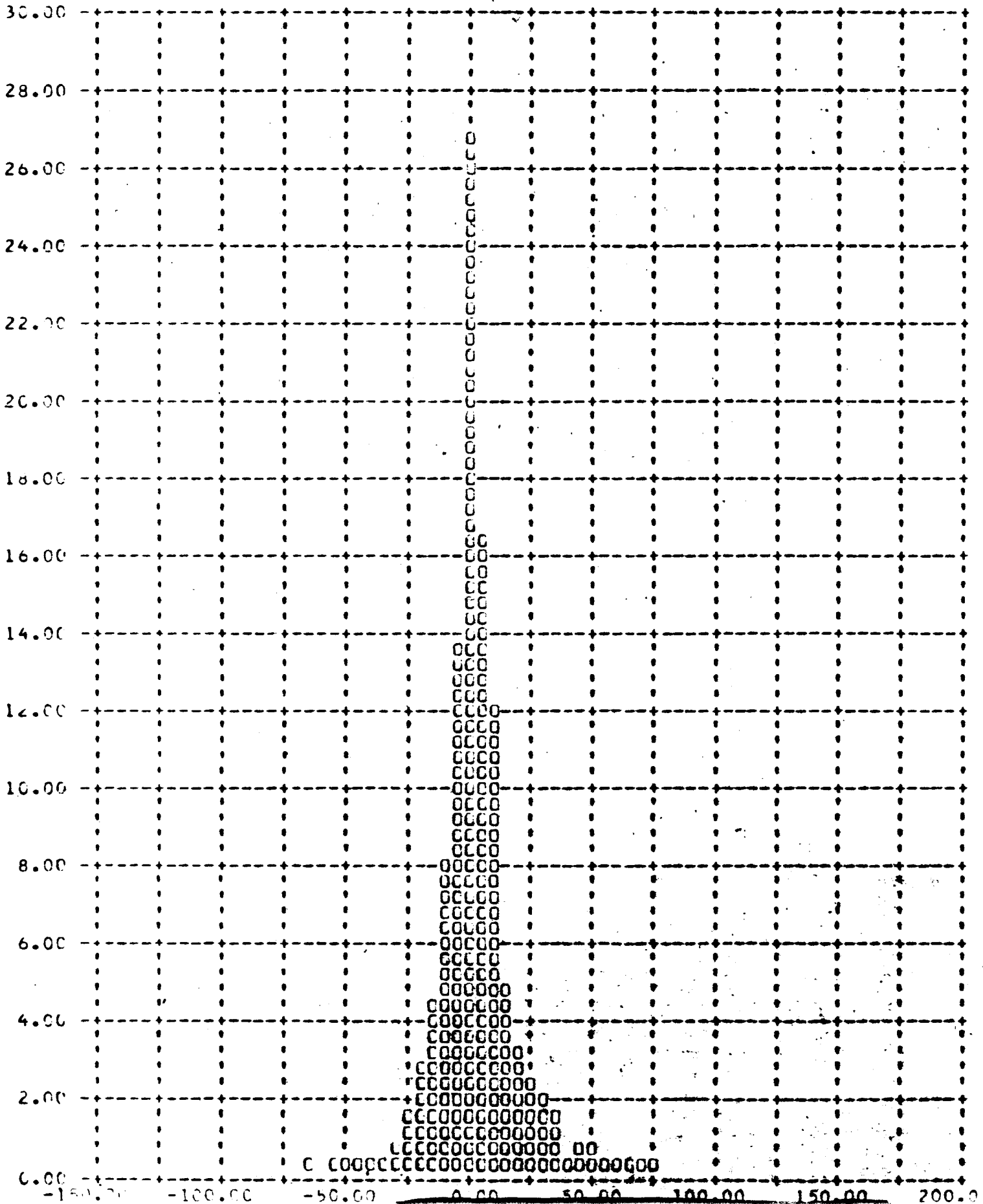

J-29 A-BUCKET FORWARD INSTRUME FRAMES 1-6 OF EACH OP OMITTED 90 PERCENT = 36.0

Y YAW RATE ERROR - DEG/FLUR (X) VERSUS FREQUENCY - PERCENT (Y)

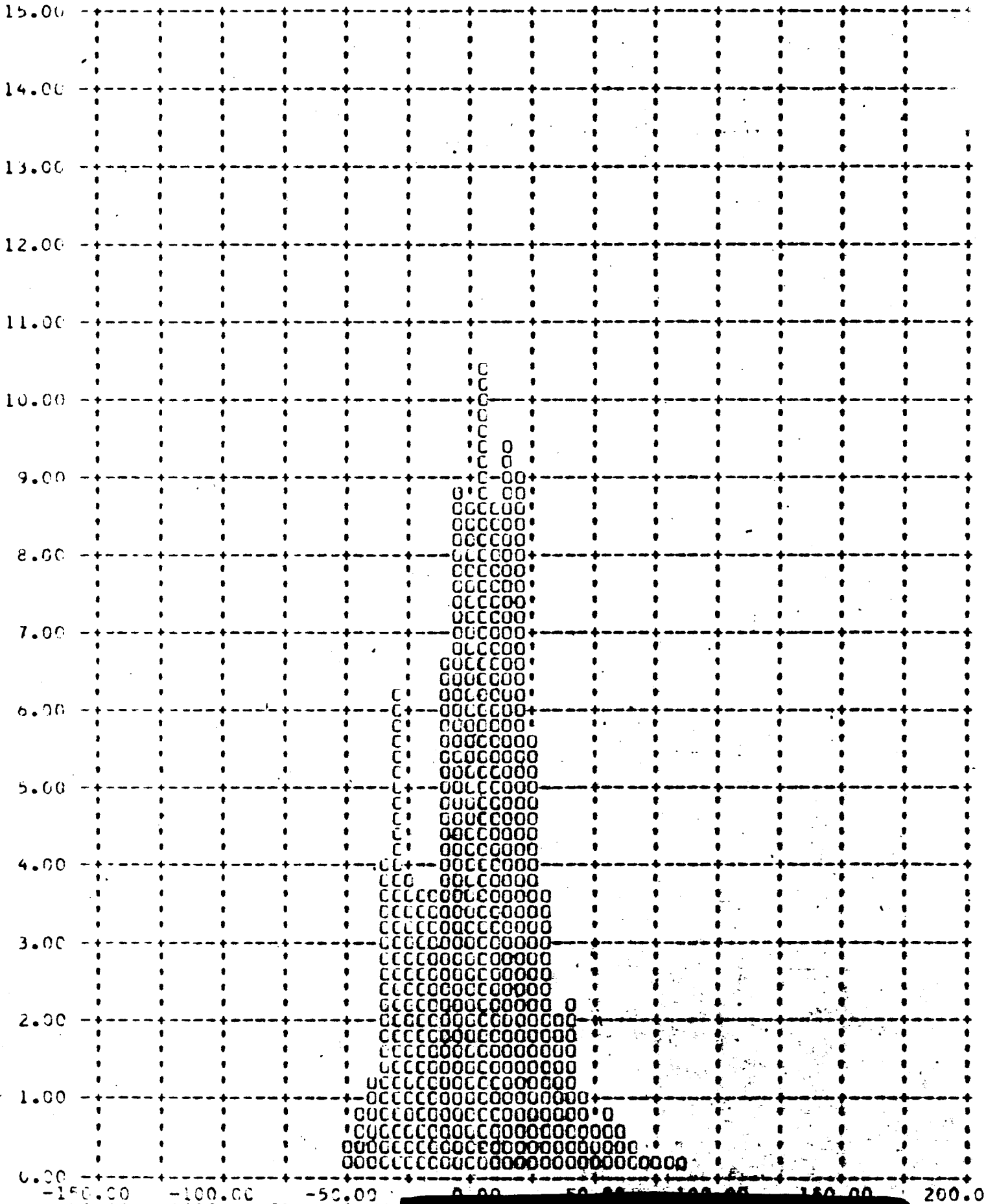

29 B-BUCKET FORWARD INSTRUMEN FRAMES 1-6 OF EACH UP OMITTED 90 PERCENT = 0.70

Y PITCH ANGLE ERROR - DEGREES (X) VERSUS FREQUENCY - PERCENT (Y)

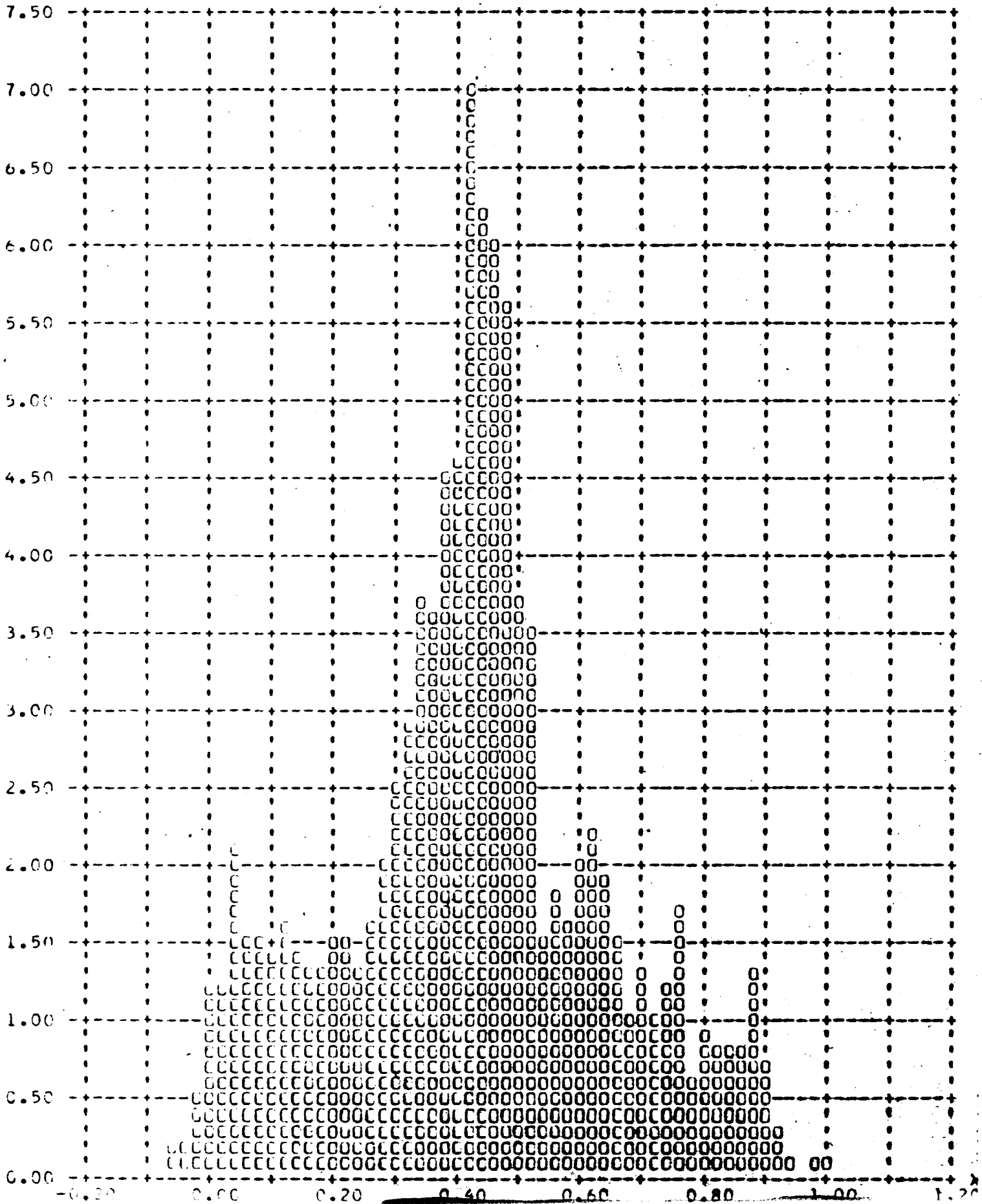

29 B-BUCKET FORWARD INSTRUMENT FRAMES 1-6 OF EACH OP. OMITTED 90 PERCENT = 0.27

Y ROLL ANGLE ERROR - DEGREES (X) VERSUS FREQUENCY - PERCENT (Y)

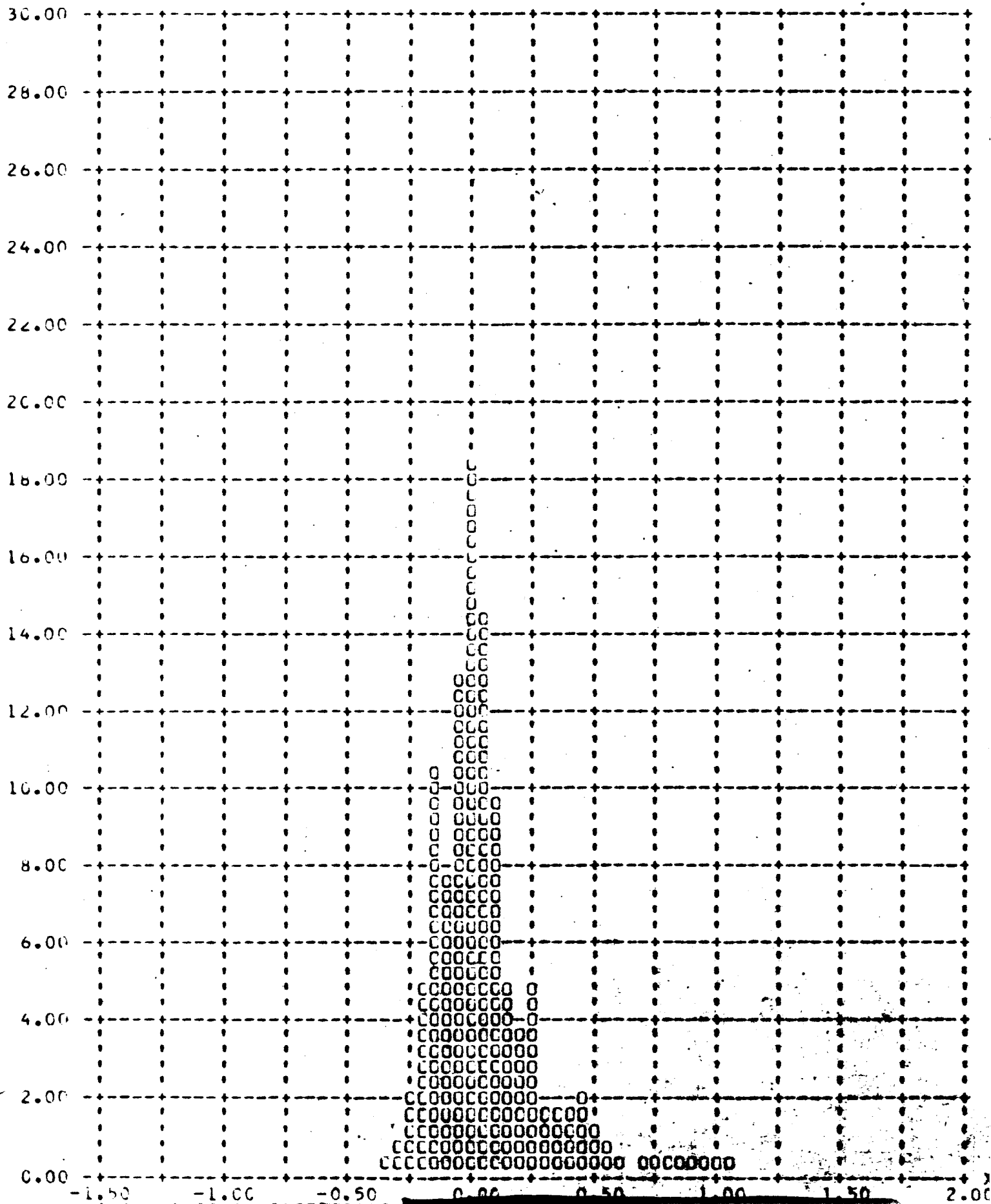

DENSITY VALUE	PRIMARY		INTERMEDIATE			FULL			ALL LEVELS		
	MIN	MAX LIM	MIN	MAX	LIM	MIN	MAX	LIM	MIN	MAX	LIM
2.01	0	0	0	0	0	0	0	1	0	0	0
2.02	0	0	0	0	0	0	0	0	0	0	0
2.03	0	0	0	0	0	0	0	0	0	0	0
2.04	0	0	0	0	0	0	0	0	0	0	0
2.05	0	0	0	0	0	0	0	0	0	0	0
2.06	0	0	0	0	0	0	0	0	0	0	0
2.07	0	0	0	0	0	0	0	0	0	0	0
2.08	0	0	0	0	0	0	0	0	0	0	0
2.09	0	0	0	0	0	0	0	0	0	0	0
2.10	0	0	0	0	0	0	0	0	0	0	0
2.11	0	0	0	0	0	0	0	0	0	0	0
2.12	0	0	0	0	0	0	0	0	0	0	0
2.13	0	0	0	0	0	0	0	0	0	0	0
2.14	0	0	0	0	0	0	0	0	0	0	0
2.15	0	0	0	0	0	0	0	0	0	0	0
2.16	0	0	0	0	0	0	0	0	0	0	0
2.17	0	0	0	0	0	0	0	0	0	0	0
2.18	0	0	0	0	0	0	0	0	0	0	0
2.19	0	0	0	0	0	0	0	0	0	0	0
2.20	0	0	0	0	0	0	0	0	0	0	0
2.21	0	0	0	0	0	0	0	0	0	0	0
2.22	0	0	0	0	0	0	0	0	0	0	0
2.23	0	0	0	0	0	0	0	0	0	0	0
2.24	0	0	0	0	0	0	0	0	0	0	0
2.25	0	0	0	0	0	0	0	0	0	0	0
2.26	0	0	0	0	0	0	0	0	0	0	0
2.27	0	0	0	0	0	0	0	0	0	0	0
2.28	0	0	0	0	0	0	0	0	0	0	0
2.29	0	0	0	0	0	0	0	0	0	0	0
2.30	0	0	0	0	0	0	0	0	0	0	0
2.31	0	0	0	0	0	0	0	0	0	0	0
2.32	0	0	0	0	0	0	0	0	0	0	0
2.33	0	0	0	0	0	0	0	0	0	0	0
2.34	0	0	0	0	0	0	0	0	0	0	0
2.35	0	0	0	0	0	0	0	0	0	0	0
2.36	0	0	0	0	0	0	0	0	0	0	0
2.37	0	0	0	0	0	0	0	0	0	0	0
2.38	0	0	0	0	0	0	0	0	0	0	0
2.39	0	0	0	0	0	0	0	0	0	0	0
2.40	0	0	0	0	0	0	0	0	0	0	0
2.41	0	0	0	0	0	0	0	0	0	0	0
2.42	0	0	0	0	0	0	0	0	0	0	0
2.43	0	0	0	0	0	0	0	0	0	0	0
2.44	0	0	0	0	0	0	0	0	0	0	0
2.45	0	0	0	0	0	0	0	0	0	0	0
2.46	0	0	0	0	0	0	0	0	0	0	0
2.47	0	0	0	0	0	0	0	0	0	0	0
2.48	0	0	0	0	0	0	0	0	0	0	0
2.49	0	0	0	0	0	0	0	0	0	0	0
2.50	0	0	0	0	0	0	0	0	0	0	0
2.51	0	0	0	0	0	0	0	0	0	0	0
2.52	0	0	0	0	0	0	0	0	0	0	0
2.53	0	0	0	0	0	0	0	0	0	0	0
2.54	0	0	0	0	0	0	0	0	0	0	0
2.55	0	0	0	0	0	0	0	0	0	0	0
2.56	0	0	0	0	0	0	0	0	0	0	0
2.57	0	0	0	0	0	0	0	0	0	0	0
2.58	0	0	0	0	0	0	0	0	0	0	0
2.59	0	0	0	0	0	0	0	0	0	0	0
2.60	0	0	0	0	0	0	0	0	0	0	0
2.61	0	0	0	0	0	0	0	0	0	0	0
2.62	0	0	0	0	0	0	0	0	0	0	0
2.63	0	0	0	0	0	0	0	0	0	0	0
2.64	0	0	0	0	0	0	0	0	0	0	0
2.65	0	0	0	0	0	0	0	0	0	0	0
2.66	0	0	0	0	0	0	0	0	0	0	0
2.67	0	0	0	0	0	0	0	0	0	0	0
2.68	0	0	0	0	0	0	0	0	0	0	0
2.69	0	0	0	0	0	0	0	0	0	0	0
2.70	0	0	0	0	0	0	0	0	0	0	0
2.71	0	0	0	0	0	0	0	0	0	0	0
2.72	0	0	0	0	0	0	0	0	0	0	0
2.73	0	0	0	0	0	0	0	0	0	0	0
2.74	0	0	0	0	0	0	0	0	0	0	0
2.75	0	0	0	0	0	0	0	0	0	0	0
2.76	0	0	0	0	0	0	0	0	0	0	0
2.77	0	0	0	0	0	0	0	0	0	0	0
2.78	0	0	0	0	0	0	0	0	0	0	0
2.79	0	0	0	0	0	0	0	0	0	0	0
2.80	0	0	0	0	0	0	0	0	0	0	0
2.81	0	0	0	0	0	0	0	0	0	0	0
2.82	0	0	0	0	0	0	0	0	0	0	0
2.83	0	0	0	0	0	0	0	0	0	0	0
2.84	0	0	0	0	0	0	0	0	0	0	0
2.85	0	0	0	0	0	0	0	0	0	0	0
2.86	0	0	0	0	0	0	0	0	0	0	0
2.87	0	0	0	0	0	0	0	0	0	0	0
2.88	0	0	0	0	0	0	0	0	0	0	0
2.89	0	0	0	0	0	0	0	0	0	0	0
2.90	0	0	0	0	0	0	0	0	0	0	0
2.91	0	0	0	0	0	0	0	0	0	0	0
2.92	0	0	0	0	0	0	0	0	0	0	0
2.93	0	0	0	0	0	0	0	0	0	0	0
2.94	0	0	0	0	0	0	0	0	0	0	0
2.95	0	0	0	0	0	0	0	0	0	0	0
2.96	0	0	0	0	0	0	0	0	0	0	0
2.97	0	0	0	0	0	0	0	0	0	0	0
2.98	0	0	0	0	0	0	0	0	0	0	0
2.99	0	0	0	0	0	0	0	0	0	0	0
2.00	0	0	0	0	0	0	0	0	0	0	0

Table A-1

MISSION * 1030-1 * INSTRUMENT * FRWD 8/25/66 DENSITY FREQ DISTR

DENSITY VALUE	PRIMARY			INTERMEDIATE			FULL			ALL LEVELS		
	MIN	MAX	LIM	MIN	MAX	LIM	MIN	MAX	LIM	MIN	MAX	LIM
2.00			0			0			0			0
2.05			0			0			0			0
2.10			0			0			0			0
2.15			0			0			0			0
2.20			0			0			0			0
2.25			0			0			0			0
2.30			0			0			0			0
2.35			0			0			0			0
2.40			0			0			0			0
2.45			0			0			0			0
2.50			0			0			0			0
2.55			0			0			0			0
2.60			0			0			0			0
2.65			0			0			0			0
2.70			0			0			0			0
2.75			0			0			0			0
2.80			0			0			0			0
2.85			0			0			0			0
2.90			0			0			0			0
2.95			0			0			0			0
3.00			0			0			0			0
SUBTOTAL			0			0			0			0
TOTAL			2	127	127	102	117	117	106	246	246	210

MISSION 1030-1 INSTR - FRWD 8/25/66 PROCESSING AND EXPOSURE ANALYSIS

PROJECT LEVEL	SAMPLE SIZE	UNDER EXPOSED	UNDER PROCESSED	CORRECT EXP+PROC	OVER PROCESSED	OVER EXPOSED
PRIMARY	2	0 PC	0 PC	50 PC	0 PC	50 PC
INTERMEDIATE	127	0 PC	6 PC	59 PC	27 PC	3 PC
FULL	117	0 PC	0 PC	62 PC	27 PC	1 PC
ALL LEVELS	246	0 PC	3 PC	61 PC	28 PC	5 PC

PROJECT LEVEL	RANGE	UNDER EXPOSED	UNDER PROCESSED	CORRECT EXP+PROC	OVER PROCESSED	OVER EXPOSED
PRIMARY	0.01-0.09	0.01-0.03	0.14-0.39	0.40-0.90	-----	0.91 AND UP
INTERMEDIATE	0.10-0.17	0.01-0.20	0.21-0.39	0.40-0.90	0.91-1.34	1.35 AND UP
FULL	0.18 AND UP	0.01-0.39	-----	0.40-0.90	0.91-1.59	1.70 AND UP

Table A-1

[REDACTED]

METHOD: [REDACTED] PRIMARY
APPROXIMATE MEAN: [REDACTED] 2.5

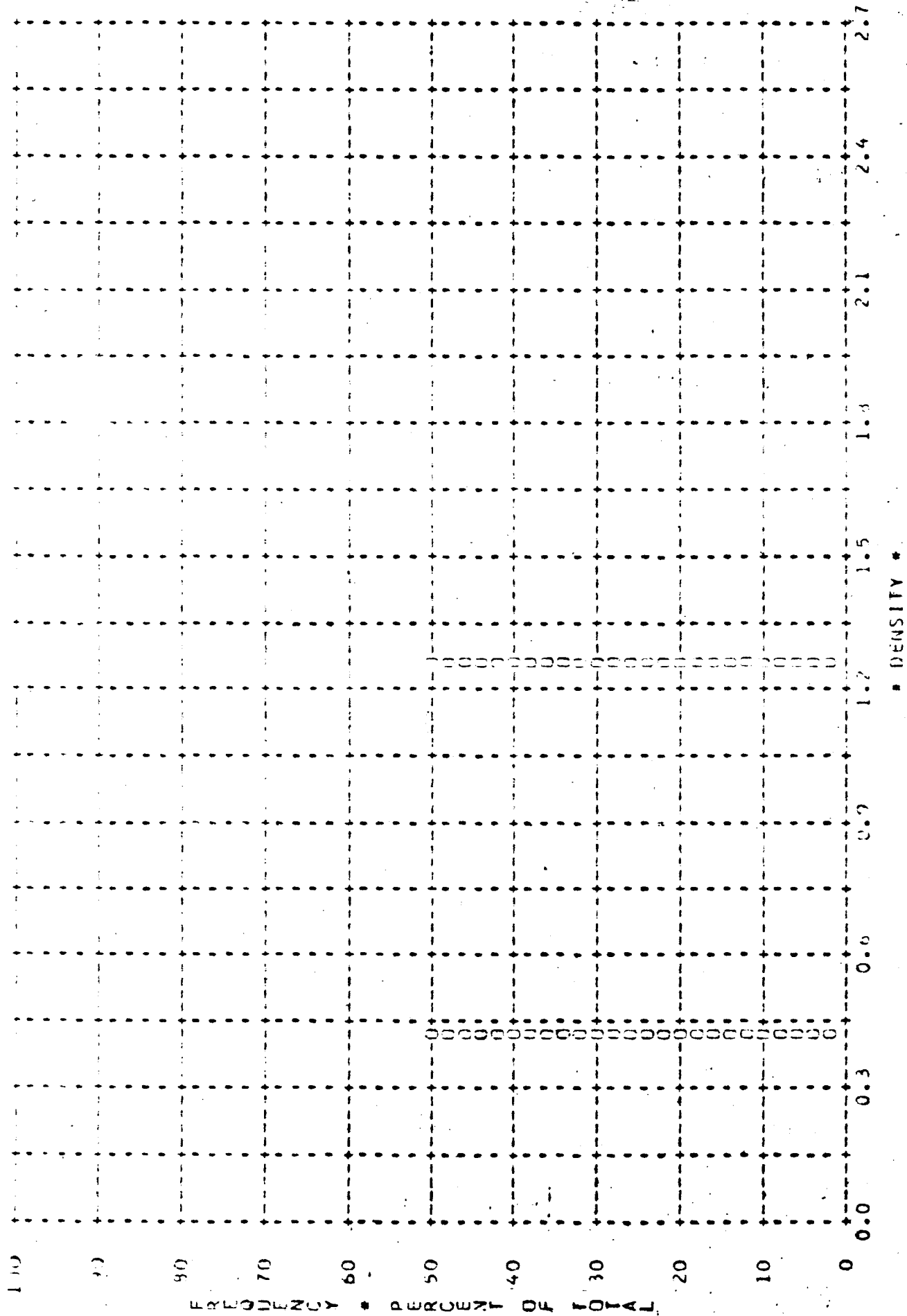

Figure A-1

[REDACTED]

TOP SECRET

~~TOP SECRET~~

MISSION • 1039-1 • LOSTER • 1300 • 872 706 UNIT OF D MAX • 0000 • PROCESSING • PRIMARY
APPROXIMATE • 1.77 • MEAN • 1.33 • STD DEV • 0.60 • RANGE • 1.7 TO 2.43 MTS • 2 SAMPLES

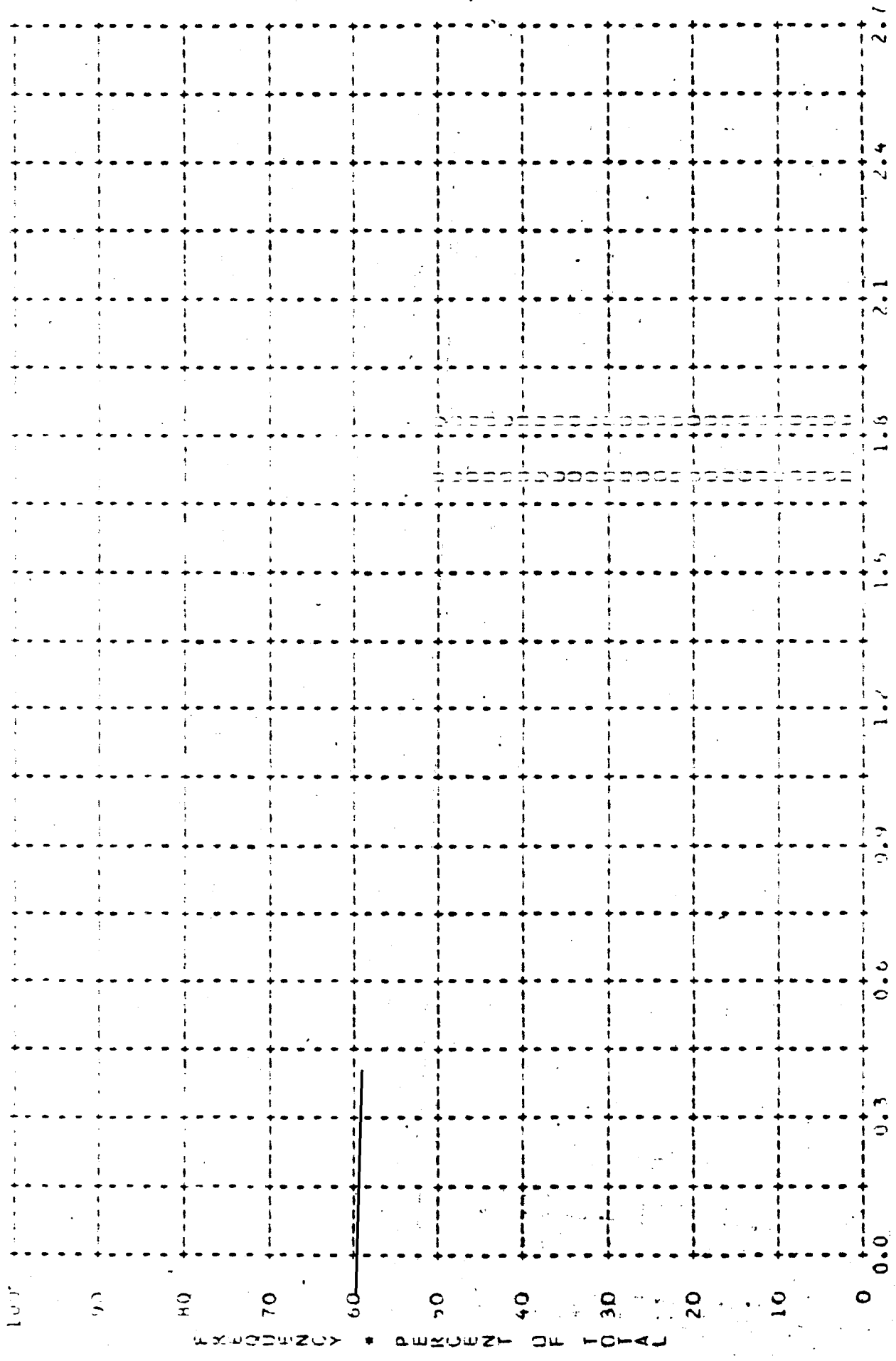

• DENSITY •

~~TOP SECRET~~

Figure A-3



MTS 100 • 1000-1 • 1.16 • 1.42 • 1.77 • 2.07 • 2.41 • 2.81 • 3.21 • 3.61 • 4.01 • 4.41 • 4.81 • 5.21 • 5.61 • 6.01 • 6.41 • 6.81 • 7.21 • 7.61 • 8.01 • 8.41 • 8.81 • 9.21 • 9.61 • 10.01

ARTICLE NO.	1.77	2.07	2.41	2.81	3.21	3.61	4.01	4.41	4.81	5.21	5.61	6.01	6.41	6.81	7.21	7.61	8.01	8.41	8.81	9.21	9.61	10.01	
10																							
9																							
8																							
7																							
6																							
5																							
4																							
3																							
2																							
1																							
0																							

FREQUENCY • PERCENT OF TOTAL

• DENSITY •



Figure A-5

MISSION: [REDACTED] * INTERMEDIATE * PROCESSING * INTERMEDIATE *
ARTICLE No: [REDACTED] * DENSITY * 1.5 * 1.6 * 1.7 * 1.8 * 1.9 * 2.0 * 2.1 * 2.4 * 2.7

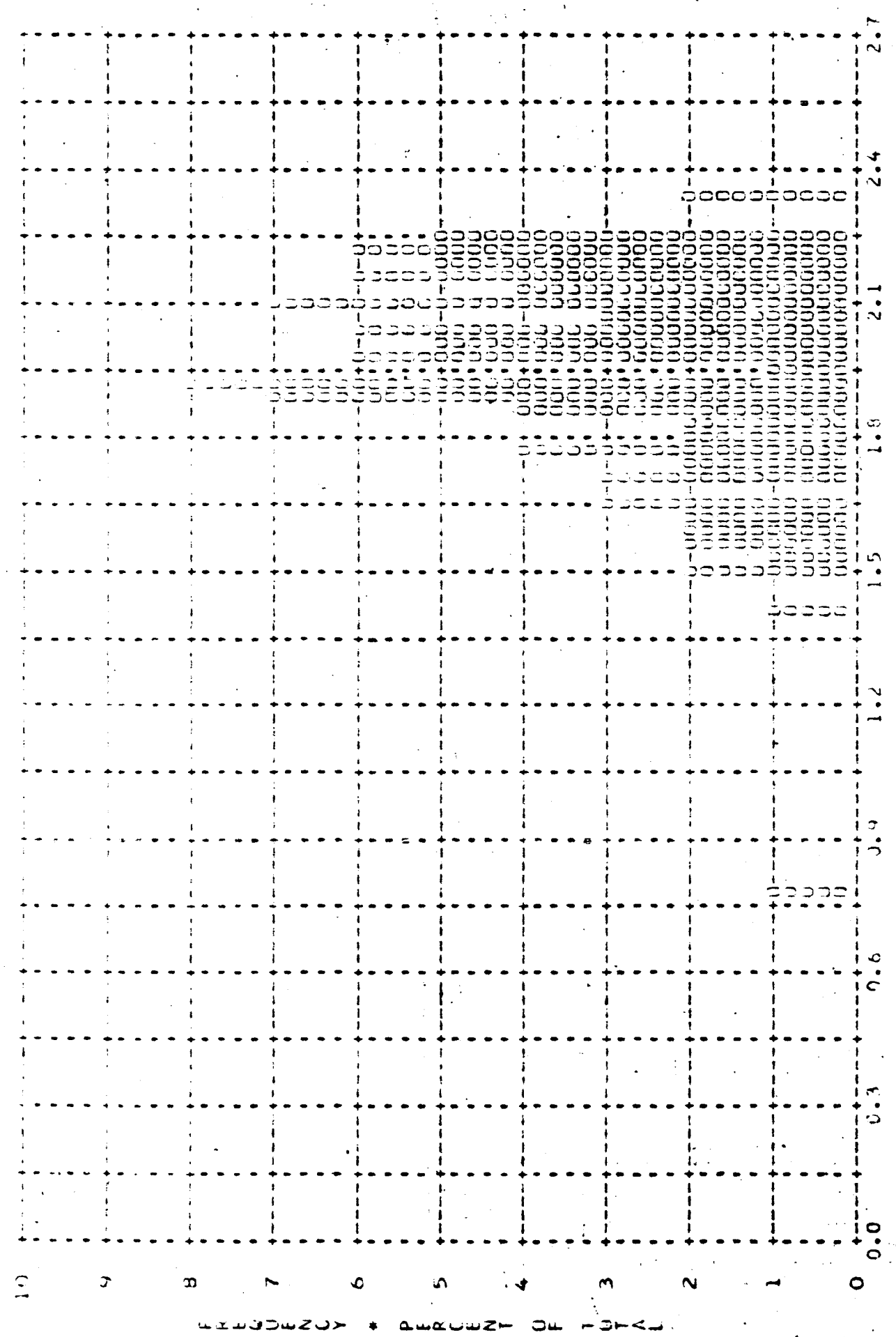

FREQUENCY * PERCENT OF TOTAL

* DENSITY *

Figure A-6

MESSAGE ID: 1000-1
 FREQUENCY: 2.73 * 10^10
 PERCENT OF TOTAL: 6.00
 117 500000

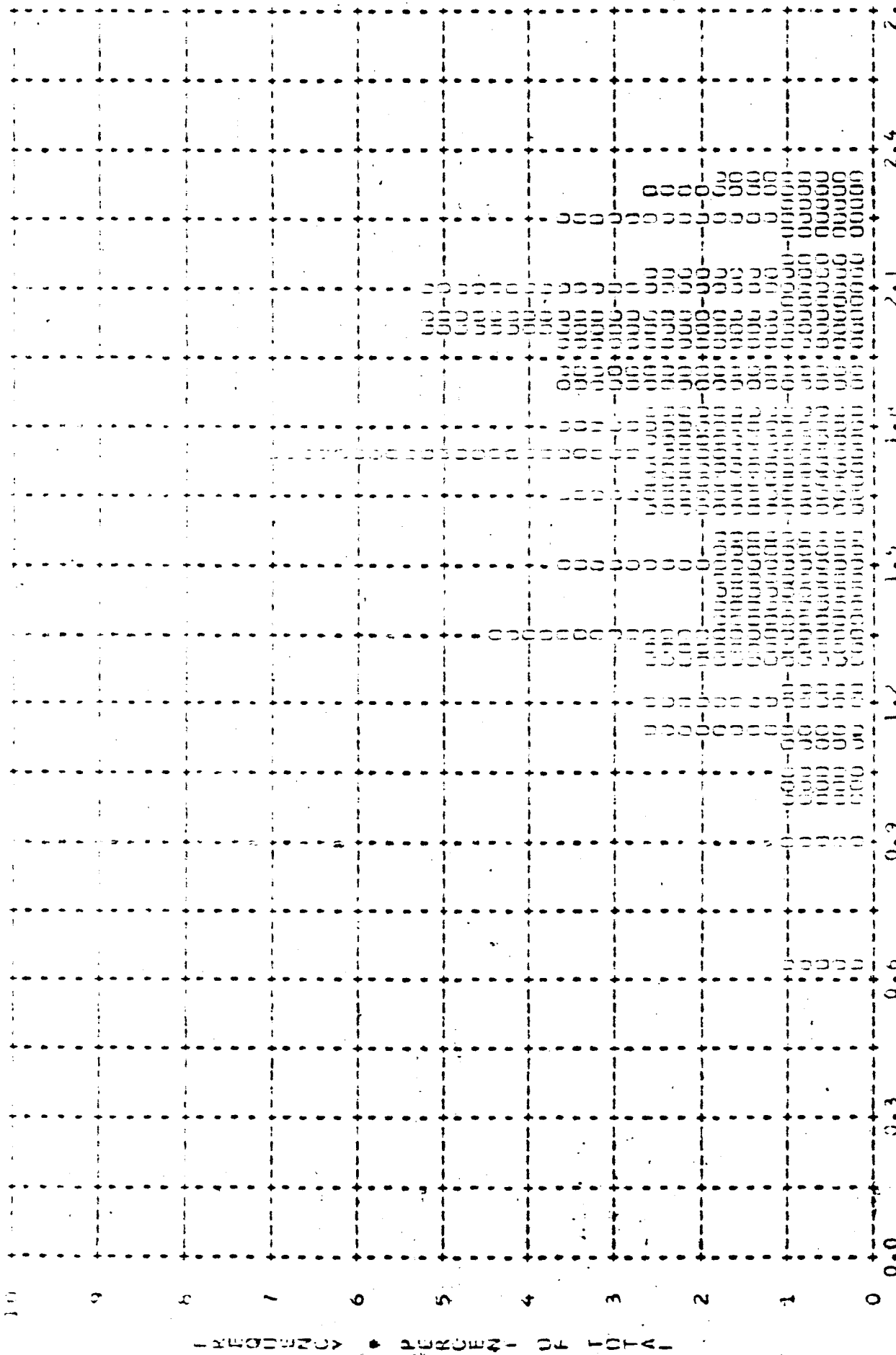

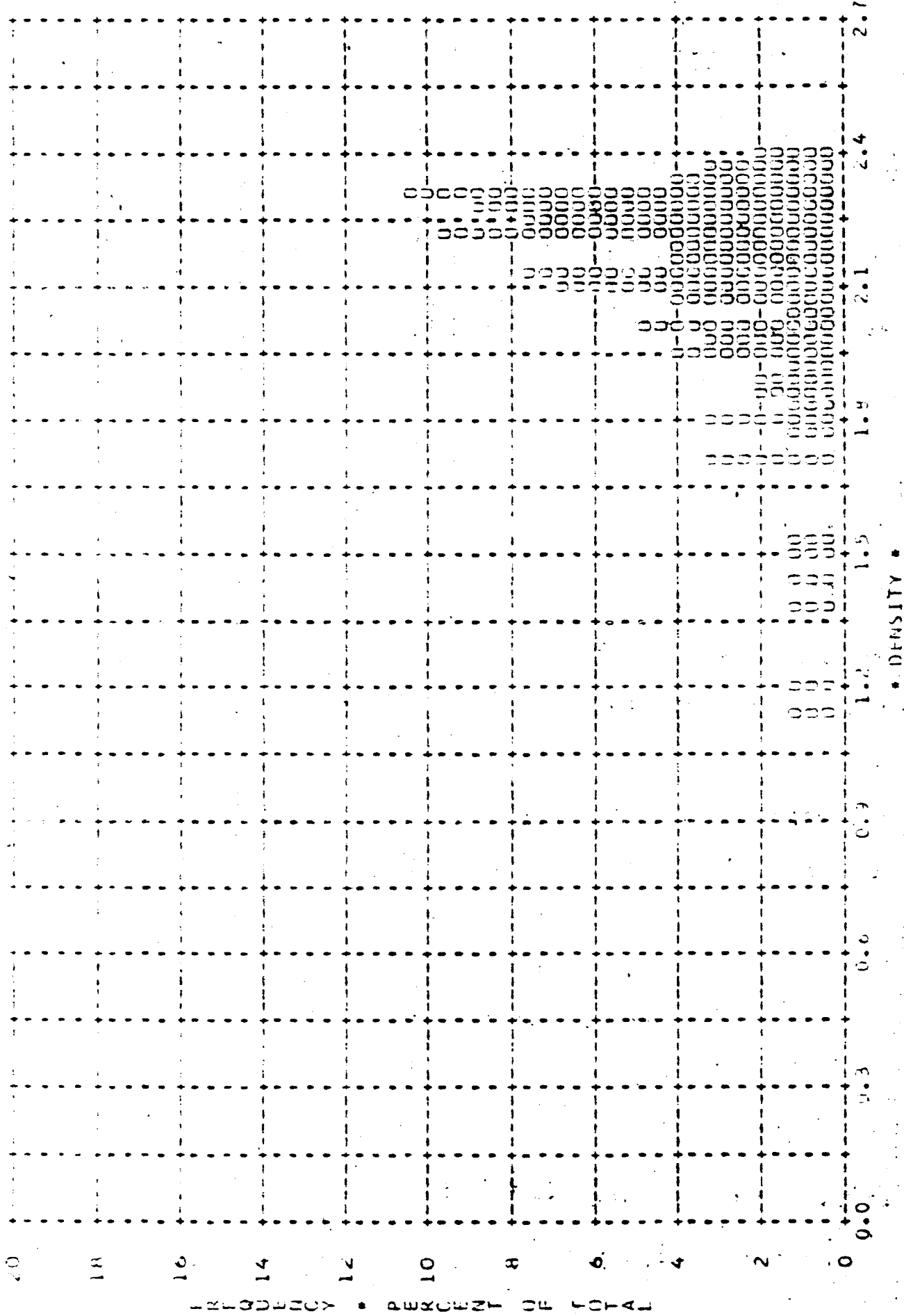

100% COUNT

Figure A-9

MISSION 10500 * ESTIMATED * 7/1966 * PLOT OF D-17 * U.S.M.I. * PROCESSING * ALL LEVELS
ARTICLE NO. 001 * ANALYSIS * 7/1966 * 100 * 0.35 * PAGE * 0.27 * 1.56 * WITH 266 SAMPLES

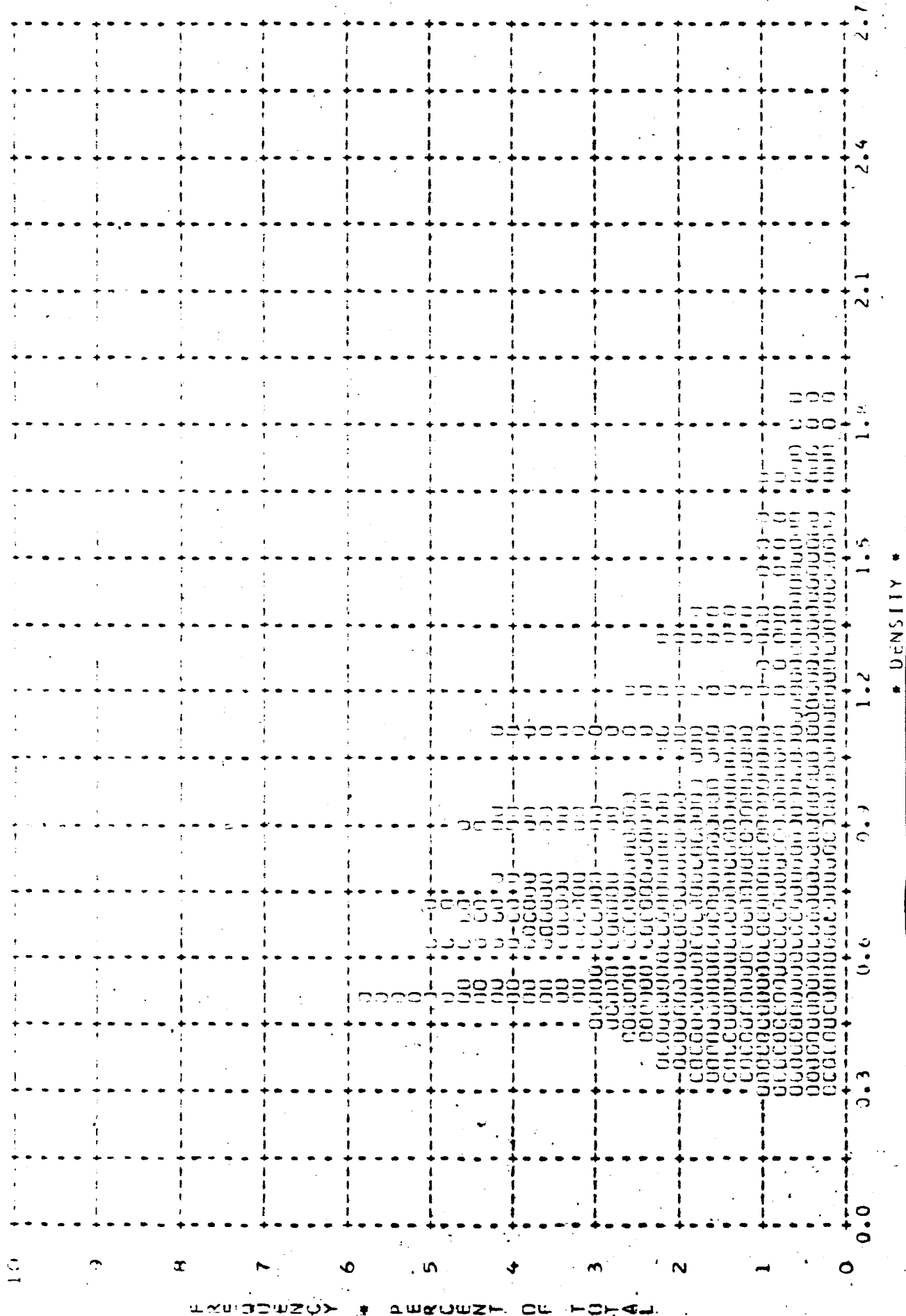

TOP SECRET

Figure A-10

[REDACTED]

MISSION * 1030-1 * 14518 * 18.00 * 277756 PLOT OF 0 MAX * TOTAL * PROCESSING * ALL LEVEL *
ARITH MEAN * 1.70 * MEDIAN * 1.70 * 1.00 DET * .34 * RANGE * 0.61 To 2.36 WITH 246 SAMPLES

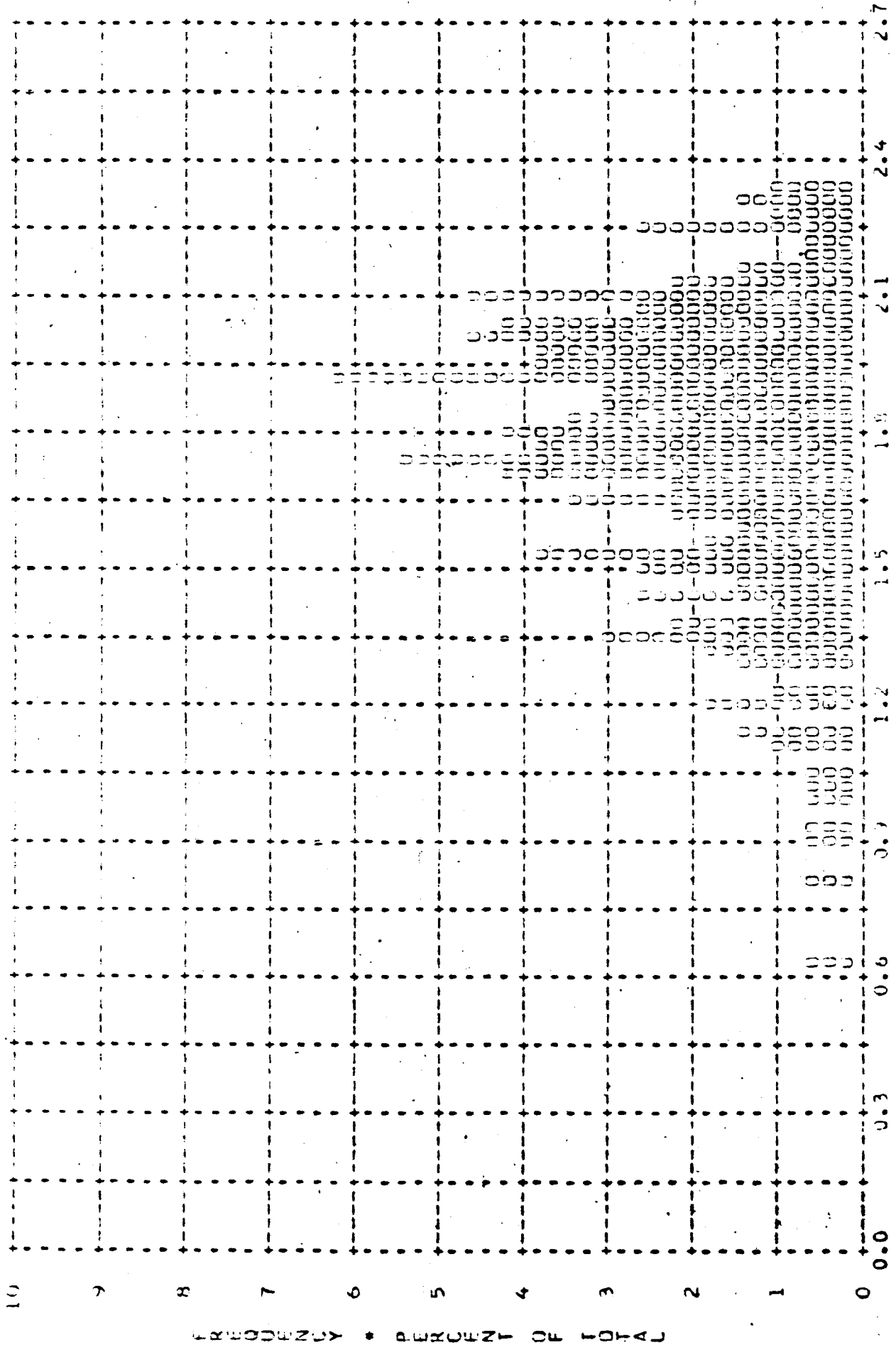

[REDACTED]

Figure A-11

RESIDUALS FROM THE ANALYSIS OF THE DATA FROM THE PROCESSING OF ALL LEVELS
 WITHIN THE RANGE OF 0.1 TO 1.0 IN THE RANGE OF 0.1 TO 1.0 WITH 216 SAMPLES

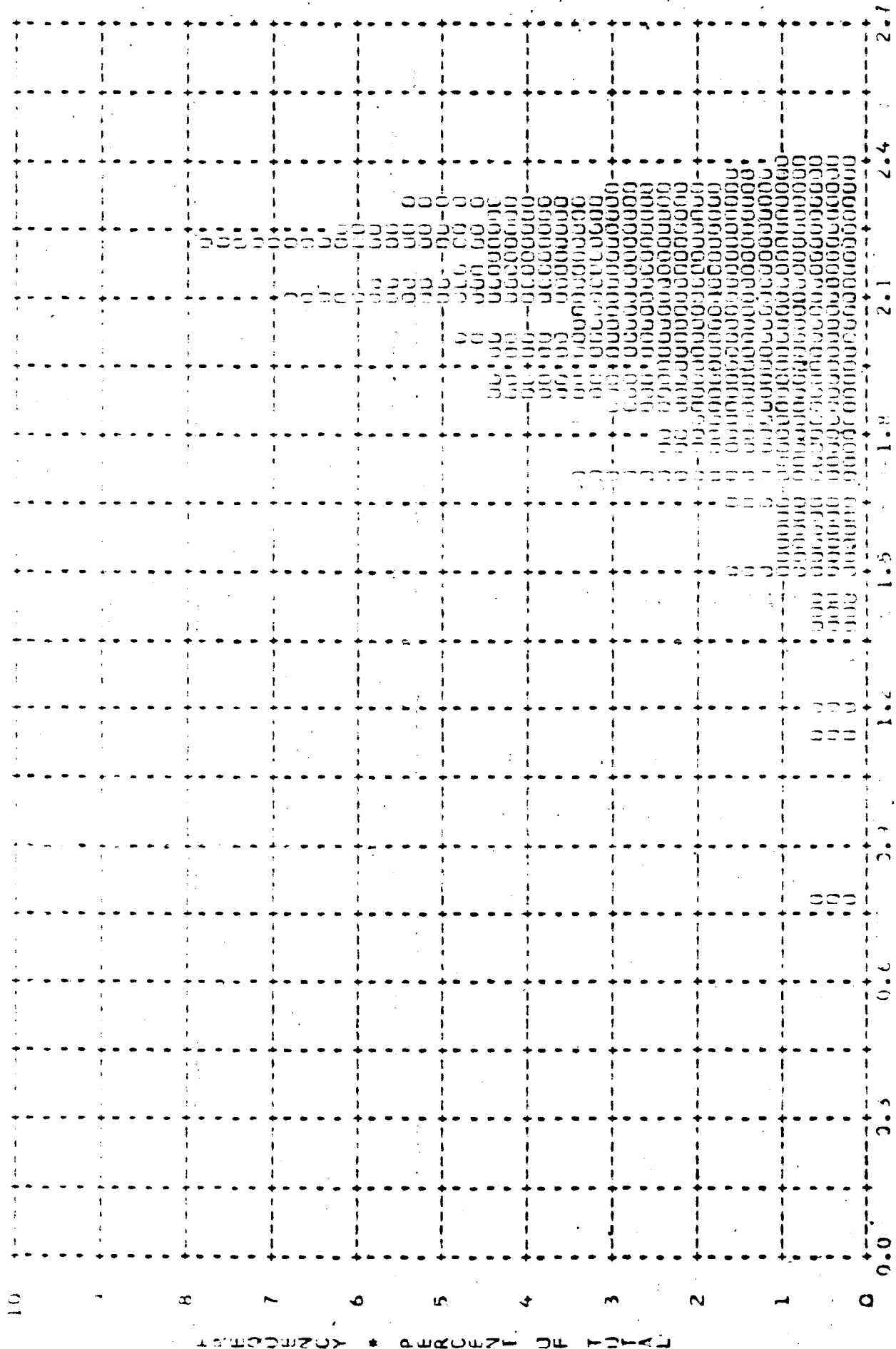

~~TOP SECRET~~

Figure A-12

~~TOP SECRET~~



INSTRUMENT • AFT 8/25/66 DENSITY FREQ DISTR.

DENSITY VALUES	PRIMARY			INTERMEDIATE			FULL			ALL LEVELS		
	MIN	MAX	LIM	MIN	MAX	LIM	MIN	MAX	LIM	MIN	MAX	LIM
0.01												
0.02												
0.03												
0.04												
0.05												
0.06												
0.07												
0.08												
0.09												
0.10												
0.11												
0.12												
0.13												
0.14												
0.15												
0.16												
0.17												
0.18												
0.19												
0.20												
0.21												
0.22												
0.23												
0.24												
0.25												
0.26												
0.27												
0.28												
0.29												
0.30												
0.31												
0.32												
0.33												
0.34												
0.35												
0.36												
0.37												
0.38												
0.39												
0.40												
0.41												
0.42												
0.43												
0.44												
0.45												
0.46												
0.47												
0.48												
0.49												
0.50												
0.51												
0.52												
0.53												
0.54												
0.55												
0.56												
0.57												
0.58												
0.59												
0.60												
0.61												
0.62												
0.63												
0.64												
0.65												
0.66												
0.67												
0.68												
0.69												
0.70												
0.71												
0.72												
0.73												
0.74												
0.75												
0.76												
0.77												
0.78												
0.79												
0.80												
0.81												
0.82												
0.83												
0.84												
0.85												
0.86												
0.87												
0.88												
0.89												
0.90												
0.91												
0.92												
0.93												
0.94												
0.95												
0.96												
0.97												
0.98												
0.99												
1.00												

SUB

~~TOP SECRET~~



Table A-2

DENSITY VALUE	PRIMARY		INTERMEDIATE			FULL			ALL LEVELS			
	MIN	MAX	LIM	MIN	MAX	LIM	MIN	MAX	LIM	MIN	MAX	LIM
0.51				2			0			2		
0.52							0					
0.53							0					
0.54							0					
0.55							0					
0.56							0					
0.57							0					
0.58							0					
0.59							0					
0.60							0					
0.61							0					
0.62							0					
0.63							0					
0.64							0					
0.65							0					
0.66							0					
0.67							0					
0.68							0					
0.69							0					
0.70							0					
0.71							0					
0.72							0					
0.73							0					
0.74							0					
0.75							0					
0.76							0					
0.77							0					
0.78							0					
0.79							0					
0.80							0					
0.81							0					
0.82							0					
0.83							0					
0.84							0					
0.85							0					
0.86							0					
0.87							0					
0.88							0					
0.89							0					
0.90							0					
0.91							0					
0.92							0					
0.93							0					
0.94							0					
0.95							0					
0.96							0					
0.97							0					
0.98							0					
0.99							0					
1.00							0					
SUBTOTAL				104			76			24		

Table A-2

DENSITY VALUES	PRIMARY		INTERMEDIATE			FULL			ALL LEVELS			
	MIN	MAX	LIM	MIN	MAX	LIM	MIN	MAX	LIM	MIN	MAX	LIM
1												
2												
3												
4												
5												
6												
7												
8												
9												
10												
11												
12												
13												
14												
15												
16												
17												
18												
19												
20												
21												
22												
23												
24												
25												
26												
27												
28												
29												
30												
31												
32												
33												
34												
35												
36												
37												
38												
39												
40												
41												
42												
43												
44												
45												
46												
47												
48												
49												
50												
51												
52												
53												
54												
55												
56												
57												
58												
59												
60												
61												
62												
63												
64												
65												
66												
67												
68												
69												
70												
71												
72												
73												
74												
75												
76												
77												
78												
79												
80												
81												
82												
83												
84												
85												
86												
87												
88												
89												
90												
91												
92												
93												
94												
95												
96												
97												
98												
99												
100												

SUBTOTAL

Table A-2

DENSITY VALUE	PRIMARY		INTERMEDIATE			FULL			ALL LEVELS			
	MIN	MAX LIM	MIN	MAX	LIM	MIN	MAX	LIM	MIN	MAX	LIM	
0												
1												
2												
3												
4												
5												
6												
7												
8												
9												
10												
11												
12												
13												
14												
15												
16												
17												
18												
19												
20												
21												
22												
23												
24												
25												
26												
27												
28												
29												
30												
31												
32												
33												
34												
35												
36												
37												
38												
39												
40												
41												
42												
43												
44												
45												
46												
47												
48												
49												
50												
51												
52												
53												
54												
55												
56												
57												
58												
59												
60												
61												
62												
63												
64												
65												
66												
67												
68												
69												
70												
71												
72												
73												
74												
75												
76												
77												
78												
79												
80												
81												
82												
83												
84												
85												
86												
87												
88												
89												
90												
91												
92												
93												
94												
95												
96												
97												
98												
99												
100												

Table A-2

SECRET

DENSITY VALUE	PRIMARY			INTERMEDIATE			FULL			ALL LEVELS		
	MIN	MAX	LIM	MIN	MAX	LIM	MIN	MAX	LIM	MIN	MAX	LIM
0												
1												
2												
3												
4												
5												
6												
7												
8												
9												
10												
11												
12												
13												
14												
15												
16												
17												
18												
19												
20												
21												
22												
23												
24												
25												
26												
27												
28												
29												
30												
31												
32												
33												
34												
35												
36												
37												
38												
39												
40												
41												
42												
43												
44												
45												
46												
47												
48												
49												
50												
51												
52												
53												
54												
55												
56												
57												
58												
59												
60												
61												
62												
63												
64												
65												
66												
67												
68												
69												
70												
71												
72												
73												
74												
75												
76												
77												
78												
79												
80												
81												
82												
83												
84												
85												
86												
87												
88												
89												
90												
91												
92												
93												
94												
95												
96												
97												
98												
99												
100												

SECRET

Table A-2

~~TOP SECRET~~

MISSION * 1030-1 * INSTRUMENT * AFT 9/25/66 DENSITY FREQ DISTR

QUALITY VALUE	PRIMARY			INTERMEDIATE			FULL			ALL LEVELS		
	MIN	MAX	LIM	MIN	MAX	LIM	MIN	MAX	LIM	MIN	MAX	LIM
0.00	0	0	0	0	0	0	0	0	0	0	0	0
0.01	0	0	0	0	0	0	0	0	0	0	0	0
0.02	0	0	0	0	0	0	0	0	0	0	0	0
0.03	0	0	0	0	0	0	0	0	0	0	0	0
0.04	0	0	0	0	0	0	0	0	0	0	0	0
0.05	0	0	0	0	0	0	0	0	0	0	0	0
0.06	0	0	0	0	0	0	0	0	0	0	0	0
0.07	0	0	0	0	0	0	0	0	0	0	0	0
0.08	0	0	0	0	0	0	0	0	0	0	0	0
0.09	0	0	0	0	0	0	0	0	0	0	0	0
0.10	0	0	0	0	0	0	0	0	0	0	0	0
0.11	0	0	0	0	0	0	0	0	0	0	0	0
0.12	0	0	0	0	0	0	0	0	0	0	0	0
0.13	0	0	0	0	0	0	0	0	0	0	0	0
0.14	0	0	0	0	0	0	0	0	0	0	0	0
0.15	0	0	0	0	0	0	0	0	0	0	0	0
0.16	0	0	0	0	0	0	0	0	0	0	0	0
0.17	0	0	0	0	0	0	0	0	0	0	0	0
0.18	0	0	0	0	0	0	0	0	0	0	0	0
0.19	0	0	0	0	0	0	0	0	0	0	0	0
0.20	0	0	0	0	0	0	0	0	0	0	0	0
0.21	0	0	0	0	0	0	0	0	0	0	0	0
0.22	0	0	0	0	0	0	0	0	0	0	0	0
0.23	0	0	0	0	0	0	0	0	0	0	0	0
0.24	0	0	0	0	0	0	0	0	0	0	0	0
0.25	0	0	0	0	0	0	0	0	0	0	0	0
0.26	0	0	0	0	0	0	0	0	0	0	0	0
0.27	0	0	0	0	0	0	0	0	0	0	0	0
0.28	0	0	0	0	0	0	0	0	0	0	0	0
0.29	0	0	0	0	0	0	0	0	0	0	0	0
0.30	0	0	0	0	0	0	0	0	0	0	0	0
0.31	0	0	0	0	0	0	0	0	0	0	0	0
0.32	0	0	0	0	0	0	0	0	0	0	0	0
0.33	0	0	0	0	0	0	0	0	0	0	0	0
0.34	0	0	0	0	0	0	0	0	0	0	0	0
0.35	0	0	0	0	0	0	0	0	0	0	0	0
0.36	0	0	0	0	0	0	0	0	0	0	0	0
0.37	0	0	0	0	0	0	0	0	0	0	0	0
0.38	0	0	0	0	0	0	0	0	0	0	0	0
0.39	0	0	0	0	0	0	0	0	0	0	0	0
0.40	0	0	0	0	0	0	0	0	0	0	0	0
0.41	0	0	0	0	0	0	0	0	0	0	0	0
0.42	0	0	0	0	0	0	0	0	0	0	0	0
0.43	0	0	0	0	0	0	0	0	0	0	0	0
0.44	0	0	0	0	0	0	0	0	0	0	0	0
0.45	0	0	0	0	0	0	0	0	0	0	0	0
0.46	0	0	0	0	0	0	0	0	0	0	0	0
0.47	0	0	0	0	0	0	0	0	0	0	0	0
0.48	0	0	0	0	0	0	0	0	0	0	0	0
0.49	0	0	0	0	0	0	0	0	0	0	0	0
0.50	0	0	0	0	0	0	0	0	0	0	0	0
0.51	0	0	0	0	0	0	0	0	0	0	0	0
0.52	0	0	0	0	0	0	0	0	0	0	0	0
0.53	0	0	0	0	0	0	0	0	0	0	0	0
0.54	0	0	0	0	0	0	0	0	0	0	0	0
0.55	0	0	0	0	0	0	0	0	0	0	0	0
0.56	0	0	0	0	0	0	0	0	0	0	0	0
0.57	0	0	0	0	0	0	0	0	0	0	0	0
0.58	0	0	0	0	0	0	0	0	0	0	0	0
0.59	0	0	0	0	0	0	0	0	0	0	0	0
0.60	0	0	0	0	0	0	0	0	0	0	0	0
0.61	0	0	0	0	0	0	0	0	0	0	0	0
0.62	0	0	0	0	0	0	0	0	0	0	0	0
0.63	0	0	0	0	0	0	0	0	0	0	0	0
0.64	0	0	0	0	0	0	0	0	0	0	0	0
0.65	0	0	0	0	0	0	0	0	0	0	0	0
0.66	0	0	0	0	0	0	0	0	0	0	0	0
0.67	0	0	0	0	0	0	0	0	0	0	0	0
0.68	0	0	0	0	0	0	0	0	0	0	0	0
0.69	0	0	0	0	0	0	0	0	0	0	0	0
0.70	0	0	0	0	0	0	0	0	0	0	0	0
0.71	0	0	0	0	0	0	0	0	0	0	0	0
0.72	0	0	0	0	0	0	0	0	0	0	0	0
0.73	0	0	0	0	0	0	0	0	0	0	0	0
0.74	0	0	0	0	0	0	0	0	0	0	0	0
0.75	0	0	0	0	0	0	0	0	0	0	0	0
0.76	0	0	0	0	0	0	0	0	0	0	0	0
0.77	0	0	0	0	0	0	0	0	0	0	0	0
0.78	0	0	0	0	0	0	0	0	0	0	0	0
0.79	0	0	0	0	0	0	0	0	0	0	0	0
0.80	0	0	0	0	0	0	0	0	0	0	0	0
0.81	0	0	0	0	0	0	0	0	0	0	0	0
0.82	0	0	0	0	0	0	0	0	0	0	0	0
0.83	0	0	0	0	0	0	0	0	0	0	0	0
0.84	0	0	0	0	0	0	0	0	0	0	0	0
0.85	0	0	0	0	0	0	0	0	0	0	0	0
0.86	0	0	0	0	0	0	0	0	0	0	0	0
0.87	0	0	0	0	0	0	0	0	0	0	0	0
0.88	0	0	0	0	0	0	0	0	0	0	0	0
0.89	0	0	0	0	0	0	0	0	0	0	0	0
0.90	0	0	0	0	0	0	0	0	0	0	0	0
0.91	0	0	0	0	0	0	0	0	0	0	0	0
0.92	0	0	0	0	0	0	0	0	0	0	0	0
0.93	0	0	0	0	0	0	0	0	0	0	0	0
0.94	0	0	0	0	0	0	0	0	0	0	0	0
0.95	0	0	0	0	0	0	0	0	0	0	0	0
0.96	0	0	0	0	0	0	0	0	0	0	0	0
0.97	0	0	0	0	0	0	0	0	0	0	0	0
0.98	0	0	0	0	0	0	0	0	0	0	0	0
0.99	0	0	0	0	0	0	0	0	0	0	0	0
TOTAL	0	0	0	175	173	126	72	72	69	245	245	175

MISSION 1030-1 INSTR - AFT 9/25/66 PROCESSING AND EXPOSURE ANALYSIS

PROCESS LEVEL	FAMILY SIZE	UNDER EXPOSED	UNDER PROCESSED	CORRECT EXP+PROC	OVER PROCESSED	OVER EXPOSED
PRIMARY	0	0 PC	0 PC	0 PC	0 PC	0 PC
INTERMEDIATE	173	0 PC	12 PC	65 PC	17 PC	6 PC
FULL	72	3 PC	0 PC	61 PC	35 PC	0 PC
ALL LEVELS	245	3 PC	12 PC	64 PC	22 PC	4 PC

PROCESS LEVEL	BASE RANGE	UNDER EXPOSED	UNDER PROCESSED	CORRECT EXP+PROC	OVER PROCESSED	OVER EXPOSED
PRIMARY	0.01-0.00	0.01-0.13	0.14-0.30	0.40-0.90	-----	0.91 AND UP
INTERMEDIATE	0.10-0.17	0.01-0.20	0.21-0.39	0.40-0.90	0.91-1.39	1.35 AND UP
FULL	0.14 AND UP	0.01-0.39	-----	0.40-0.90	0.91-1.59	1.70 AND UP

~~TOP SECRET~~

Table A-2

~~TOP SECRET~~

MISSIONS 103301 * 103302 * 103303 * 103304 * 103305 * 103306 * 103307 * 103308 * 103309 * 103310 * 103311 * 103312 * 103313 * 103314 * 103315 * 103316 * 103317 * 103318 * 103319 * 103320 * 103321 * 103322 * 103323 * 103324 * 103325 * 103326 * 103327 * 103328 * 103329 * 103330 * 103331 * 103332 * 103333 * 103334 * 103335 * 103336 * 103337 * 103338 * 103339 * 103340 * 103341 * 103342 * 103343 * 103344 * 103345 * 103346 * 103347 * 103348 * 103349 * 103350 * 103351 * 103352 * 103353 * 103354 * 103355 * 103356 * 103357 * 103358 * 103359 * 103360 * 103361 * 103362 * 103363 * 103364 * 103365 * 103366 * 103367 * 103368 * 103369 * 103370 * 103371 * 103372 * 103373 * 103374 * 103375 * 103376 * 103377 * 103378 * 103379 * 103380 * 103381 * 103382 * 103383 * 103384 * 103385 * 103386 * 103387 * 103388 * 103389 * 103390 * 103391 * 103392 * 103393 * 103394 * 103395 * 103396 * 103397 * 103398 * 103399 * 103400

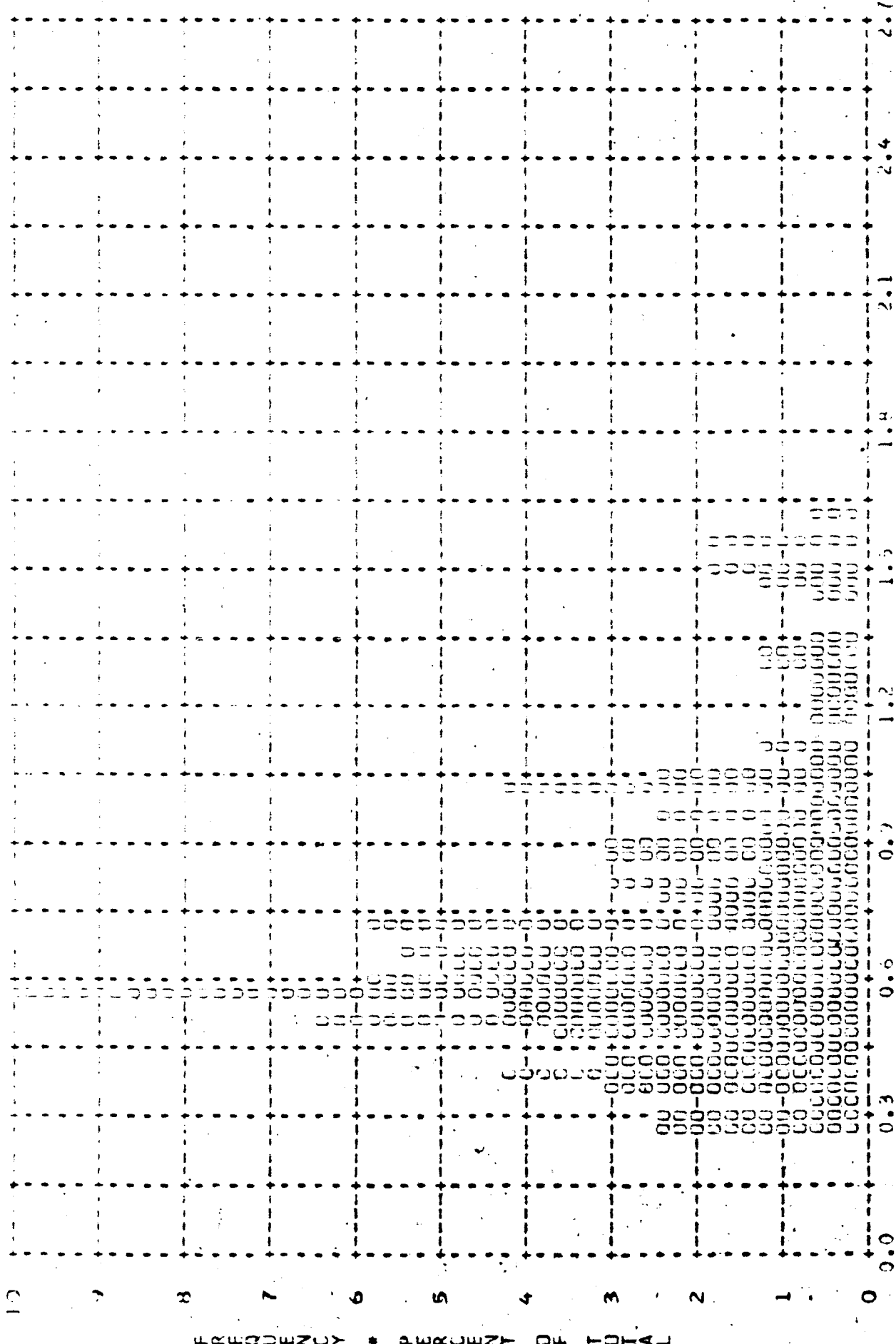

~~TOP SECRET~~

Figure A-13

[REDACTED]

MISSILE * 100-1 * INSTR * AMI * 9725/56 PLT OF D FAX * 1 RAIN * PROCESSING * INTERMEDIATE
ARITH MEAN * 1.5 * MEDIAN * 1.74 * STD DEV * 0.27 * RANGE * 0.65 TO 2.27 WITH 175 SAMPLES

	0.0	0.3	0.6	0.9	1.2	1.5	1.8	2.1	2.4	2.7
10										
9										
8										
7										
6										
5										
4										
3										
2										
1										
0										
FREQUENCY										
PERCENT										
OF										
TOTAL										
DENSITY										

[REDACTED]

TOP SECRET

UNITED STATES DEPARTMENT OF COMMERCE • BUREAU OF ECONOMIC ANALYSIS • PROCESSING • INTERNET
ARTICLE 1, 2, 3, 4, 5, 6, 7, 8, 9, 10, 11, 12, 13, 14, 15, 16, 17, 18, 19, 20, 21 WITH 126 SAMPLES

	0.0	0.3	0.6	0.9	1.2	1.5	1.8	2.1	2.4	2.7
19										
18										
17										
16										
15										
14										
13										
12										
11										
10										
9										
8										
7										
6										
5										
4										
3										
2										
1										
0										

FREQUENCY • PERCENT OF TOTAL

DENSITY

TOP SECRET

[REDACTED]

MISSILE # 1030-1 * TYPE # AT * 670756 PLOT OF FIVE * TOTAL * PROCESSING * FULL
ORIGIN # 009 * POLY # 001 * 310 # 2 * 0.29 * 0.29 * 0.33 TO 1.04 WITH 72 SAMPLES

FREQUENCY	PERCENT OF TOTAL	DENSITY
10		
9		
8		
7		
6		
5		
4		
3		
2		
1		
0		

Figure A-16

[REDACTED]

MISSILE * LOSS * TYPE * NET * 1/5/66 PERIOD OF MAX * 1.344 * PROCESSING * FULL
 ARITH MEAN * 1.71 * MEDIAN * 1.75 * STD DEV * 0.43 * RANGE * 1.13 TO 2.30 WITH 72 SAMPLES

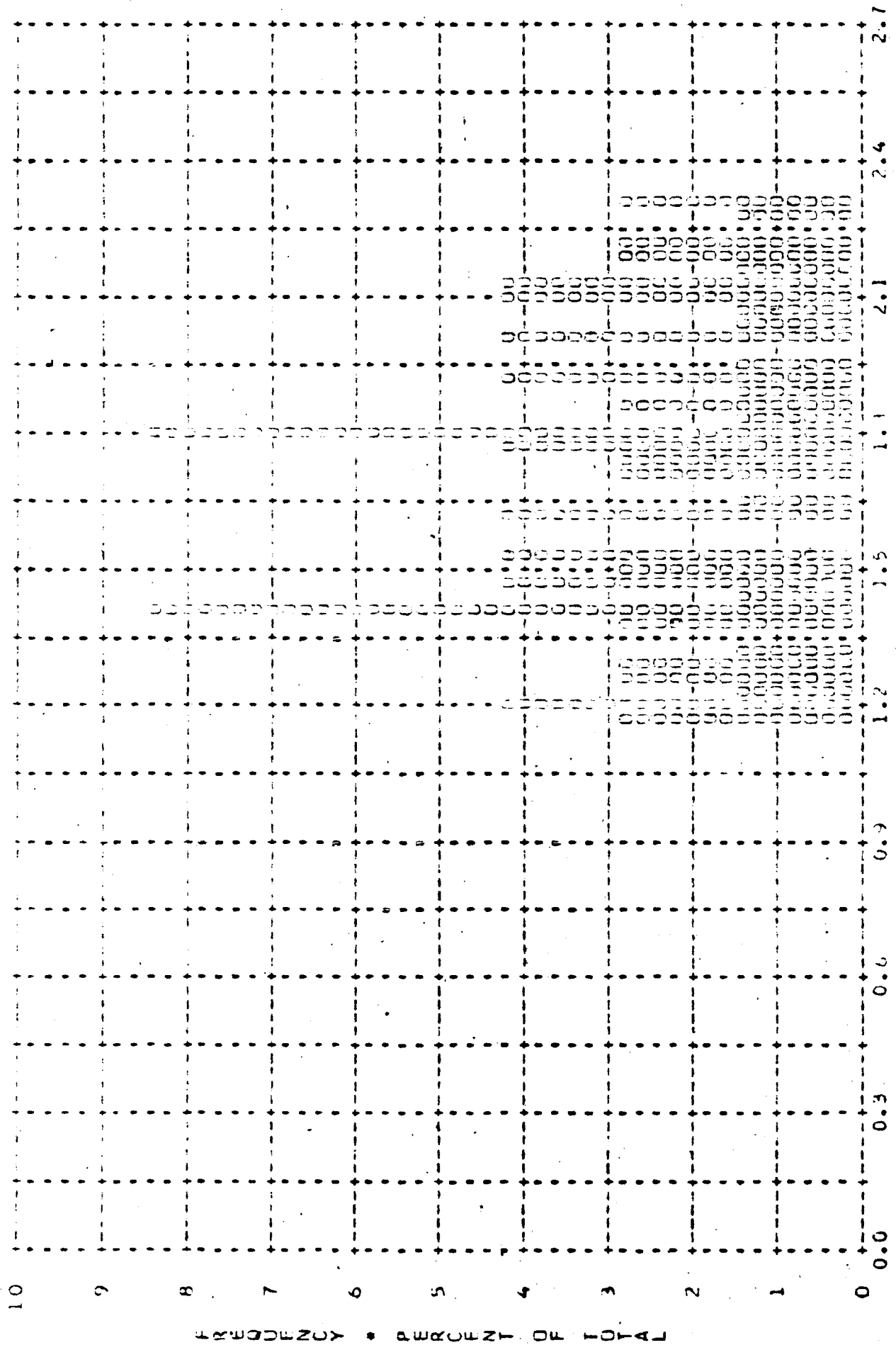
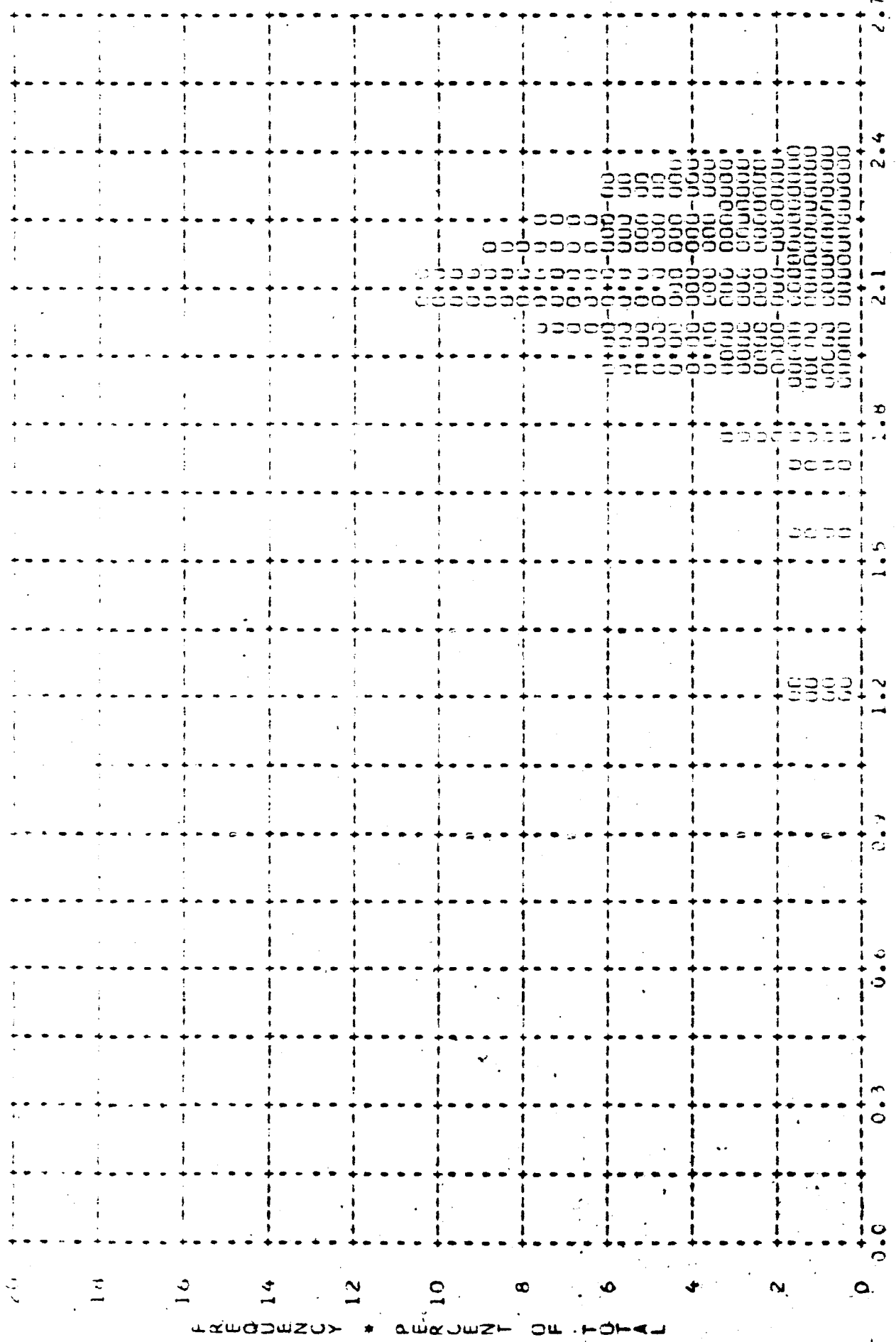

Figure A-17

~~TOP SECRET~~

REFERENCE: 1589-1, 1589-2, 1589-3, 1589-4, 1589-5, 1589-6, 1589-7, 1589-8, 1589-9, 1589-10, 1589-11, 1589-12, 1589-13, 1589-14, 1589-15, 1589-16, 1589-17, 1589-18, 1589-19, 1589-20, 1589-21, 1589-22, 1589-23, 1589-24, 1589-25, 1589-26, 1589-27, 1589-28, 1589-29, 1589-30, 1589-31, 1589-32, 1589-33, 1589-34, 1589-35, 1589-36, 1589-37, 1589-38, 1589-39, 1589-40, 1589-41, 1589-42, 1589-43, 1589-44, 1589-45, 1589-46, 1589-47, 1589-48, 1589-49, 1589-50, 1589-51, 1589-52, 1589-53, 1589-54, 1589-55, 1589-56, 1589-57, 1589-58, 1589-59, 1589-60, 1589-61, 1589-62, 1589-63, 1589-64, 1589-65, 1589-66, 1589-67, 1589-68, 1589-69, 1589-70, 1589-71, 1589-72, 1589-73, 1589-74, 1589-75, 1589-76, 1589-77, 1589-78, 1589-79, 1589-80, 1589-81, 1589-82, 1589-83, 1589-84, 1589-85, 1589-86, 1589-87, 1589-88, 1589-89, 1589-90, 1589-91, 1589-92, 1589-93, 1589-94, 1589-95, 1589-96, 1589-97, 1589-98, 1589-99, 1589-100.



DENSITY

TOP SECRET

Figure A-18

TOP SECRET

MISSION * IC 73-2 * E 1 518 * A 11 * 7/27/50 * PROF OF * P 114 * F R 1014 * P R 1014 * A U C L 1111
AMITUDE MEAN * 0.77 * MEASUREMENT * 0.31 * RANGE * 0.20 TO 1.24 WITH 245 SAMPLES

	0.0	0.3	0.6	0.9	1.2	1.5	1.8	2.1	2.4	2.7
10										
9										
8										
7										
6										
5										
4										
3										
2										
1										
0										
FREQUENCY										
PERCENT OF TOTAL										
DENSITY										

TOP SECRET

Figure A-19

MISSION • 1039-1 • 1.13R • NET • 6725/65 FLOT DE D MAX • TERRAIN • PROCESSING • ALL LEVELS
 ANTI-COAST • 1.69 • METAR • 1.74 • TO BY • 1.39 • RANGE • 1.64 TO 2.30 WITH 245 SAMPLES

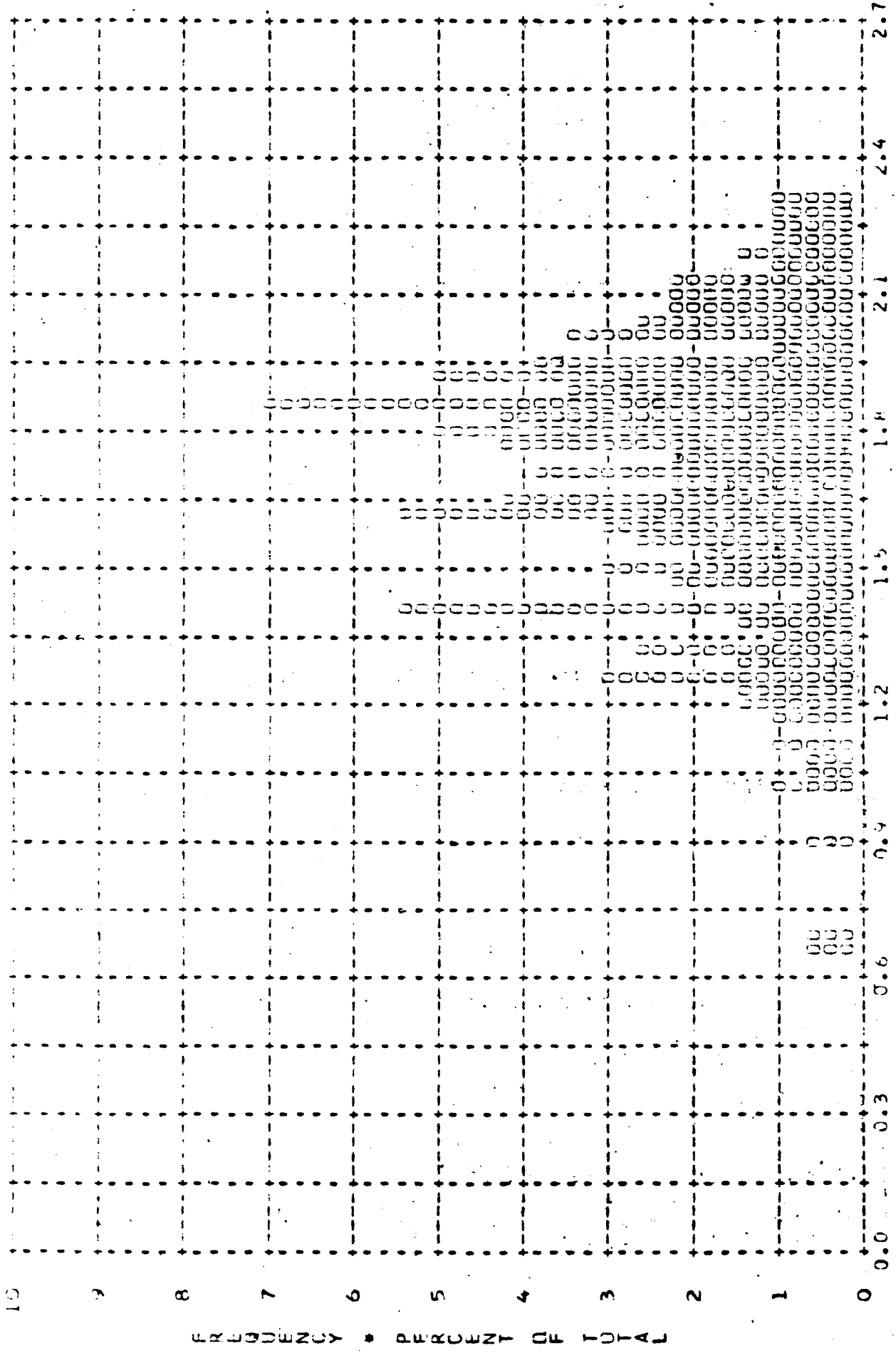

• DENSITY •

TOP SECRET

Figure A-20

TOP SECRET

MISSION # 1035-1 * DATE # 07/25/65 * PLANT # B MAX # 1 * ALL LEVELS
ARTICLE # 64 * 1.07 * MEDIA # 2.09 * SPECTRUM # 2.7 * RANGE # 1.00 - 2.00 WITH 195 SAMPLES

	0.0	0.3	0.9	1.2	1.5	1.8	2.1	2.4	2.7
10									
9									
8									
7									
6							00 0 000 00	00 0 000 00	00 0 000 00
5							00 0 000 00	00 0 000 00	00 0 000 00
4							00 0 000 00	00 0 000 00	00 0 000 00
3							00 0 000 00	00 0 000 00	00 0 000 00
2							00 0 000 00	00 0 000 00	00 0 000 00
1							00 0 000 00	00 0 000 00	00 0 000 00
0							00 0 000 00	00 0 000 00	00 0 000 00

FREQUENCY * PERCENT OF TOTAL

* DENSITY *

TOP SECRET

Figure A-21

DENSITY VALUE	PRIMARY			INTERMEDIATE			FULL			AGE LEVELS		
	MIN	MAX	LIM	MIN	MAX	LIM	MIN	MAX	LIM	MIN	MAX	LIM
0.01												
0.02												
0.03												
0.04												
0.05												
0.06												
0.07												
0.08												
0.09												
0.10												
0.11												
0.12												
0.13												
0.14												
0.15												
0.16												
0.17												
0.18												
0.19												
0.20												
0.21												
0.22												
0.23												
0.24												
0.25												
0.26												
0.27												
0.28												
0.29												
0.30												
0.31												
0.32												
0.33												
0.34												
0.35												
0.36												
0.37												
0.38												
0.39												
0.40												
0.41												
0.42												
0.43												
0.44												
0.45												
0.46												
0.47												
0.48												
0.49												
0.50												
0.51												
0.52												
0.53												
0.54												
0.55												
0.56												
0.57												
0.58												
0.59												
0.60												
0.61												
0.62												
0.63												
0.64												
0.65												
0.66												
0.67												
0.68												
0.69												
0.70												
0.71												
0.72												
0.73												
0.74												
0.75												
0.76												
0.77												
0.78												
0.79												
0.80												
0.81												
0.82												
0.83												
0.84												
0.85												
0.86												
0.87												
0.88												
0.89												
0.90												
0.91												
0.92												
0.93												
0.94												
0.95												
0.96												
0.97												
0.98												
0.99												
1.00												
SUBTOTAL												

~~TOP SECRET~~

Table A-8

DENSITY VAL	PRIMARY			INTERMEDIATE			FULL			ALL LEVELS		
	MIN	MAX	LIM	MIN	MAX	LIM	MIN	MAX	LIM	MIN	MAX	LIM
1												
2												
3												
4												
5												
6												
7												
8												
9												
10												
11												
12												
13												
14												
15												
16												
17												
18												
19												
20												
21												
22												
23												
24												
25												
26												
27												
28												
29												
30												
31												
32												
33												
34												
35												
36												
37												
38												
39												
40												
41												
42												
43												
44												
45												
46												
47												
48												
49												
50												
SUBTOTAL												

Table A-3

DENSITY VALUE	PRIMARY			INTERMEDIATE			FULL			ALL LEVELS			
	MIN	MAX	LIM	MIN	MAX	LIM	MIN	MAX	LIM	MIN	MAX	LIM	
1.51	0	0	0	0	0	1	0	0	0	0	0	0	
1.52	0	0	0	0	0	0	0	0	0	0	0	0	
1.53	0	0	0	0	0	0	0	0	0	0	0	0	
1.54	0	0	0	0	0	0	0	0	0	0	0	0	
1.55	0	0	0	0	0	0	0	0	0	0	0	0	
1.56	0	0	0	0	0	0	0	0	0	0	0	0	
1.57	0	0	0	0	0	0	0	0	0	0	0	0	
1.58	0	0	0	0	0	0	0	0	0	0	0	0	
1.59	0	0	0	0	0	0	0	0	0	0	0	0	
1.60	0	0	0	0	0	0	0	0	0	0	0	0	
1.61	0	0	0	0	0	0	0	0	0	0	0	0	
1.62	0	0	0	0	0	0	0	0	0	0	0	0	
1.63	0	0	0	0	0	0	0	0	0	0	0	0	
1.64	0	0	0	0	0	0	0	0	0	0	0	0	
1.65	0	0	0	0	0	0	0	0	0	0	0	0	
1.66	0	0	0	0	0	0	0	0	0	0	0	0	
1.67	0	0	0	0	0	0	0	0	0	0	0	0	
1.68	0	0	0	0	0	0	0	0	0	0	0	0	
1.69	0	0	0	0	0	0	0	0	0	0	0	0	
1.70	0	0	0	0	0	0	0	0	0	0	0	0	
1.71	0	0	0	0	0	0	0	0	0	0	0	0	
1.72	0	0	0	0	0	0	0	0	0	0	0	0	
1.73	0	0	0	0	0	0	0	0	0	0	0	0	
1.74	0	0	0	0	0	0	0	0	0	0	0	0	
1.75	0	0	0	0	0	0	0	0	0	0	0	0	
1.76	0	0	0	0	0	0	0	0	0	0	0	0	
1.77	0	0	0	0	0	0	0	0	0	0	0	0	
1.78	0	0	0	0	0	0	0	0	0	0	0	0	
1.79	0	0	0	0	0	0	0	0	0	0	0	0	
1.80	0	0	0	0	0	0	0	0	0	0	0	0	
1.81	0	0	0	0	0	0	0	0	0	0	0	0	
1.82	0	0	0	0	0	0	0	0	0	0	0	0	
1.83	0	0	0	0	0	0	0	0	0	0	0	0	
1.84	0	0	0	0	0	0	0	0	0	0	0	0	
1.85	0	0	0	0	0	0	0	0	0	0	0	0	
1.86	0	0	0	0	0	0	0	0	0	0	0	0	
1.87	0	0	0	0	0	0	0	0	0	0	0	0	
1.88	0	0	0	0	0	0	0	0	0	0	0	0	
1.89	0	0	0	0	0	0	0	0	0	0	0	0	
1.90	0	0	0	0	0	0	0	0	0	0	0	0	
1.91	0	0	0	0	0	0	0	0	0	0	0	0	
1.92	0	0	0	0	0	0	0	0	0	0	0	0	
1.93	0	0	0	0	0	0	0	0	0	0	0	0	
1.94	0	0	0	0	0	0	0	0	0	0	0	0	
1.95	0	0	0	0	0	0	0	0	0	0	0	0	
1.96	0	0	0	0	0	0	0	0	0	0	0	0	
1.97	0	0	0	0	0	0	0	0	0	0	0	0	
1.98	0	0	0	0	0	0	0	0	0	0	0	0	
1.99	0	0	0	0	0	0	0	0	0	0	0	0	
2.00	0	0	0	0	0	0	0	0	0	0	0	0	
SUBTOTAL					113	54		2	33	15	2	146	67

Table A-3

DENSITY VALUE	PRIMARY			INTERMEDIATE			FULL			ALL LEVELS		
	MIN	MAX	LIM	MIN	MAX	LIM	MIN	MAX	LIM	MIN	MAX	LIM
2												
3												
4												
5												
6												
7												
8												
9												
10												
11												
12												
13												
14												
15												
16												
17												
18												
19												
20												
21												
22												
23												
24												
25												
26												
27												
28												
29												
30												
31												
32												
33												
34												
35												
36												
37												
38												
39												
40												

SUBTOTAL

Table A-3

MISSION • 1030-2 • INSTRUMENT • FRWD 8/25/66 DENSITY FREQ DISTR

DENSITY VALUE	PRIMARY			INTERMEDIATE			FULL			ALL LEVELS		
	MIN	MAX	LIM	MIN	MAX	LIM	MIN	MAX	LIM	MIN	MAX	LIM
2.51	0	0	0	0	0	0	0	0	0	0	0	0
2.52	0	0	0	0	0	0	0	0	0	0	0	0
2.53	0	0	0	0	0	0	0	0	0	0	0	0
2.54	0	0	0	0	0	0	0	0	0	0	0	0
2.55	0	0	0	0	0	0	0	0	0	0	0	0
2.56	0	0	0	0	0	0	0	0	0	0	0	0
2.57	0	0	0	0	0	0	0	0	0	0	0	0
2.58	0	0	0	0	0	0	0	0	0	0	0	0
2.59	0	0	0	0	0	0	0	0	0	0	0	0
2.60	0	0	0	0	0	0	0	0	0	0	0	0
2.61	0	0	0	0	0	0	0	0	0	0	0	0
2.62	0	0	0	0	0	0	0	0	0	0	0	0
2.63	0	0	0	0	0	0	0	0	0	0	0	0
2.64	0	0	0	0	0	0	0	0	0	0	0	0
2.65	0	0	0	0	0	0	0	0	0	0	0	0
2.66	0	0	0	0	0	0	0	0	0	0	0	0
2.67	0	0	0	0	0	0	0	0	0	0	0	0
2.68	0	0	0	0	0	0	0	0	0	0	0	0
2.69	0	0	0	0	0	0	0	0	0	0	0	0
2.70	0	0	0	0	0	0	0	0	0	0	0	0
SUBTOTAL	0	0	0	0	0	0	0	0	0	0	0	0
TOTAL	0	0	0	172	172	112	74	74	60	246	246	172

MISSION 1030-2 INSTR - FRWD 8/25/66 PROCESSING AND EXPOSURE ANALY

PROCESS LEVEL	SAMPLE SIZE	UNDER EXPOSED	UNDER PROCESSED	CORRECT EXP+PROC	OVER PROCESSED	OVER EXPOSED
PRIMARY	0	0 PC	0 PC	0 PC	0 PC	0 PC
INTERMEDIATE	172	0 PC	13 PC	73 PC	12 PC	3 PC
FULL	74	16 PC	0 PC	56 PC	18 PC	0 PC
ALL LEVELS	246	5 PC	9 PC	71 PC	13 PC	2 PC

PROCESS LEVEL	RANGE	UNDER EXPOSED	UNDER PROCESSED	CORRECT EXP+PROC	OVER PROCESSED	OVER EXPOSED
PRIMARY	0.01-0.09	0.01-0.13	0.14-0.39	0.40-0.90	-----	0.91 AND
INTERMED	0.10-0.17	0.01-0.20	0.21-0.39	0.40-0.90	0.91-1.34	1.35 AND
FULL	0.18-1.00	0.01-0.39	-----	0.40-0.90	0.91-1.69	1.70 AND

Table A-3

MISSION * 1030-2 * INSTR * FRWD * R/25/56 PLUT OF L MIJ * TERAIN * PROCESSING * INTERMEDIATE
 ARITH MEAN * 0.64 * MEDIAN * 0.97 * STD DEV * 0.29 * RANGE * 0.25 TO 1.63 WITH 172 SAMPLES

A-39

PERCENT OF TOTAL

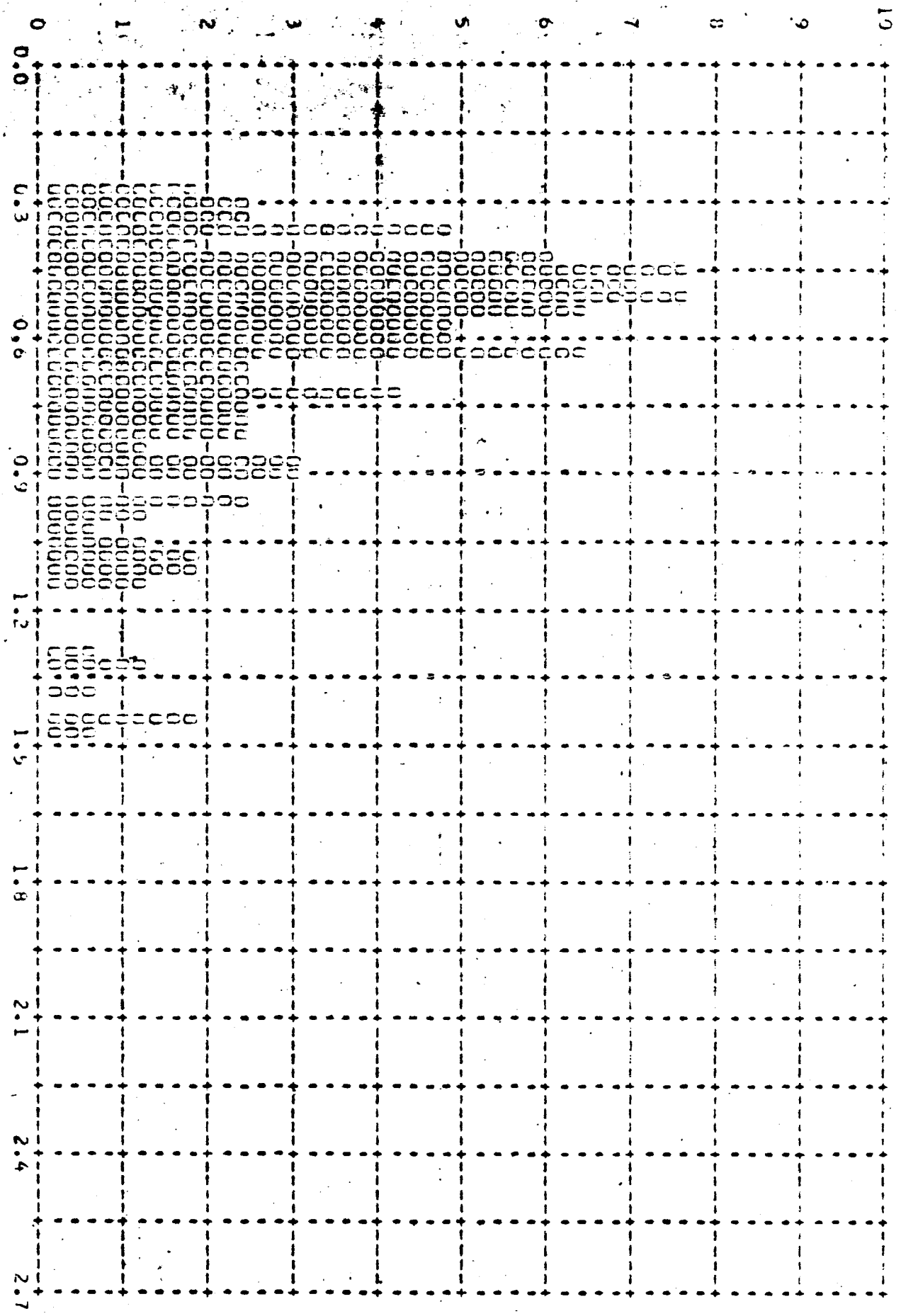

TOP SECRET

Figure A-22

[REDACTED]

MISSION * 1033-1 * TUB * FROD * 4775/56 PLOT OF 0 MAX * T RAIN * PROCESSING * INTERMEDIATE *
ARITH MEAN * 1.0 * MEDIAN * 1.73 * STD DEV * 0.23 * RANGE * 0.76 TO 2.26 WITH 172 SAMPLES

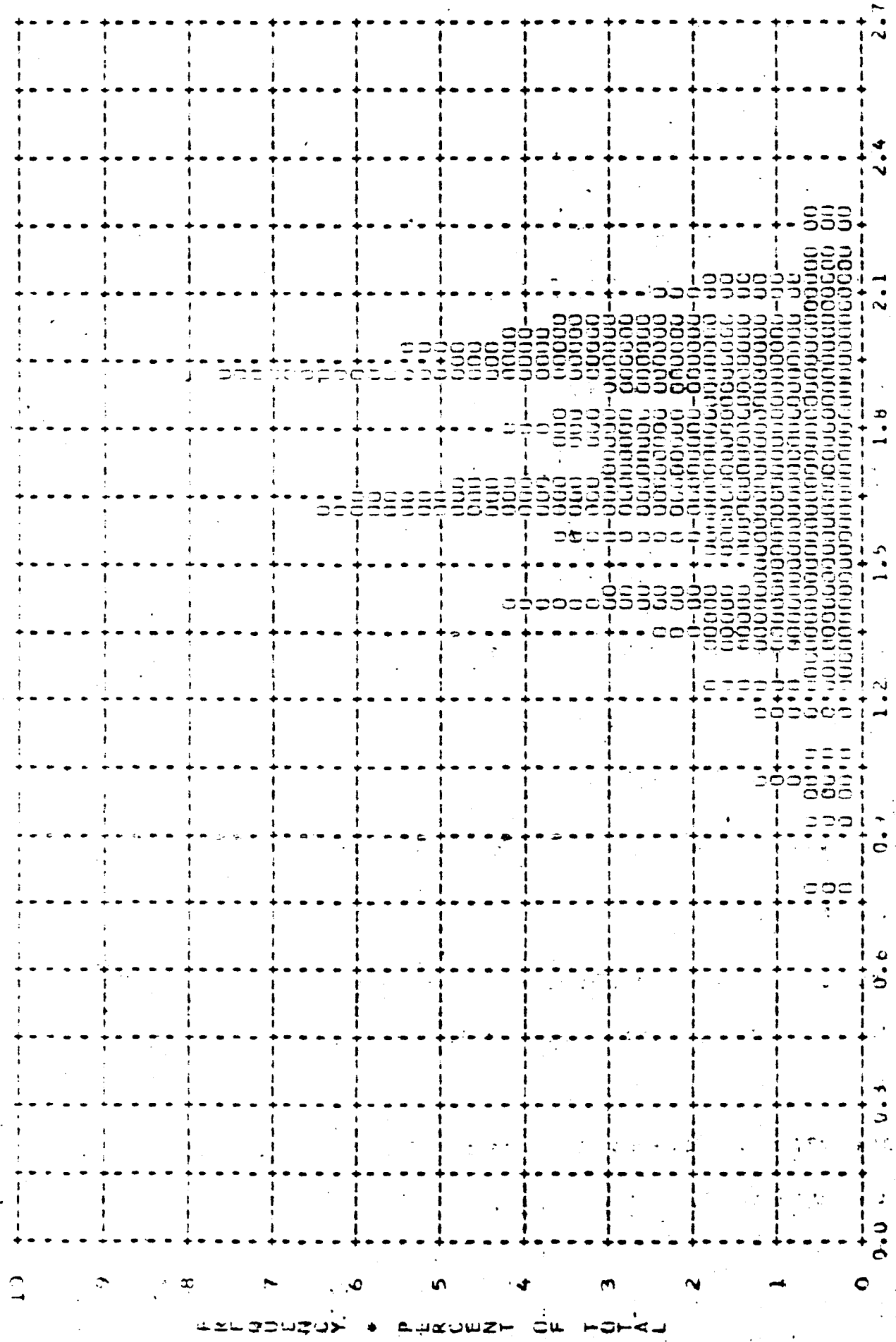

[REDACTED]

TOP SECRET

Figure A-23

MISSION * 1030-2 * EQUIP * ERDD * 7776 PLT * IF * HAK * 01 00 * PROCES * 105 * INTERMITTANT
 ARITH MEAN * 1.75 * MEDIAN * 2.00 * MOD * 1.23 * RANGE * 1.17 TO 2.23 WITH 112 SAMPLES

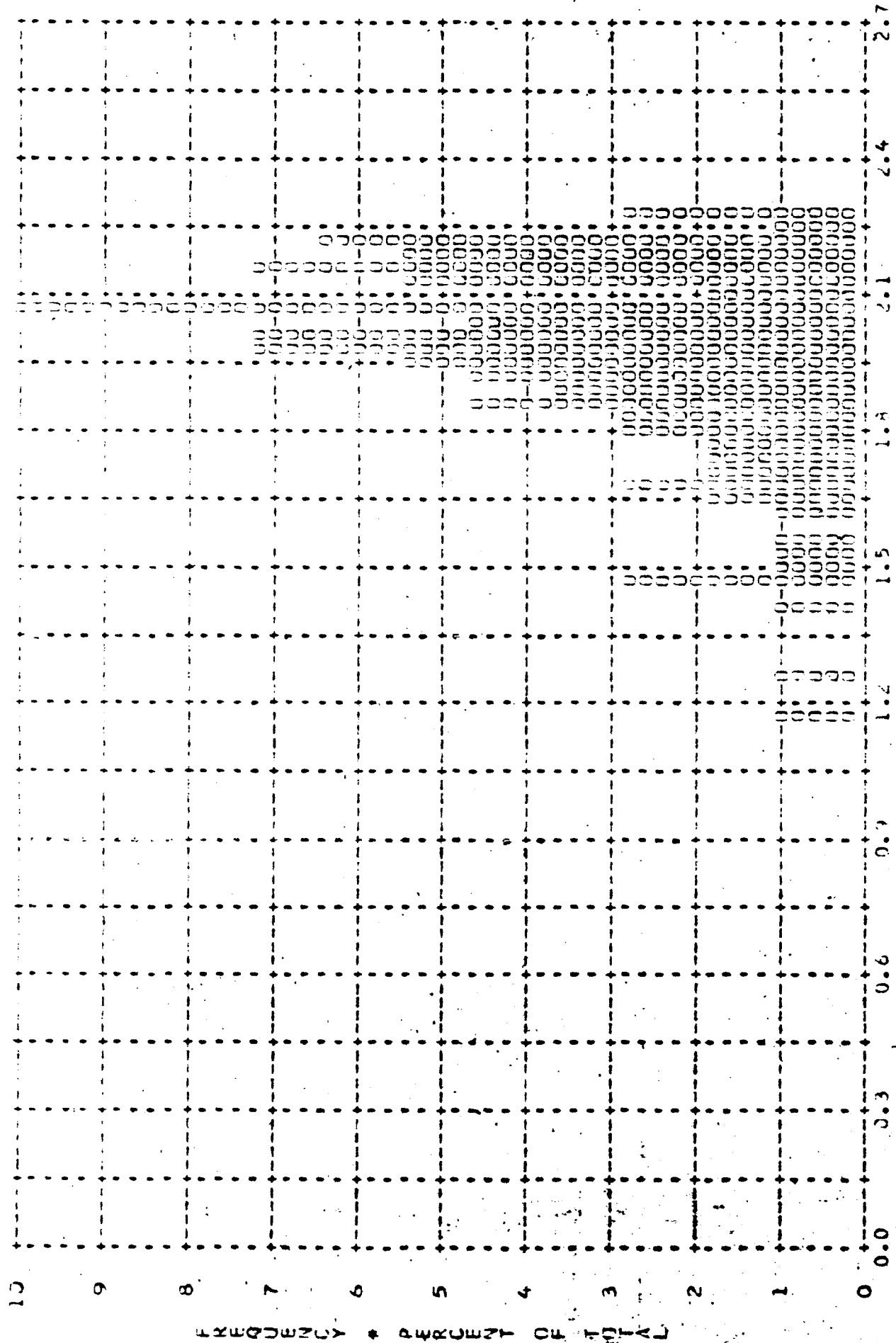

* DENSITY *

Figure A-24

TOP SECRET

MISSION * 1039- * T-28 * FRID * 4/25/66 * PLT OF D MIN * TERRAIN * PROCESSING * FULL
 ARITH MEAN * 0.56 * STD DEV * 0.33 * RANGE * 0.24 TO 1.25 WITH 74 SAMPLES

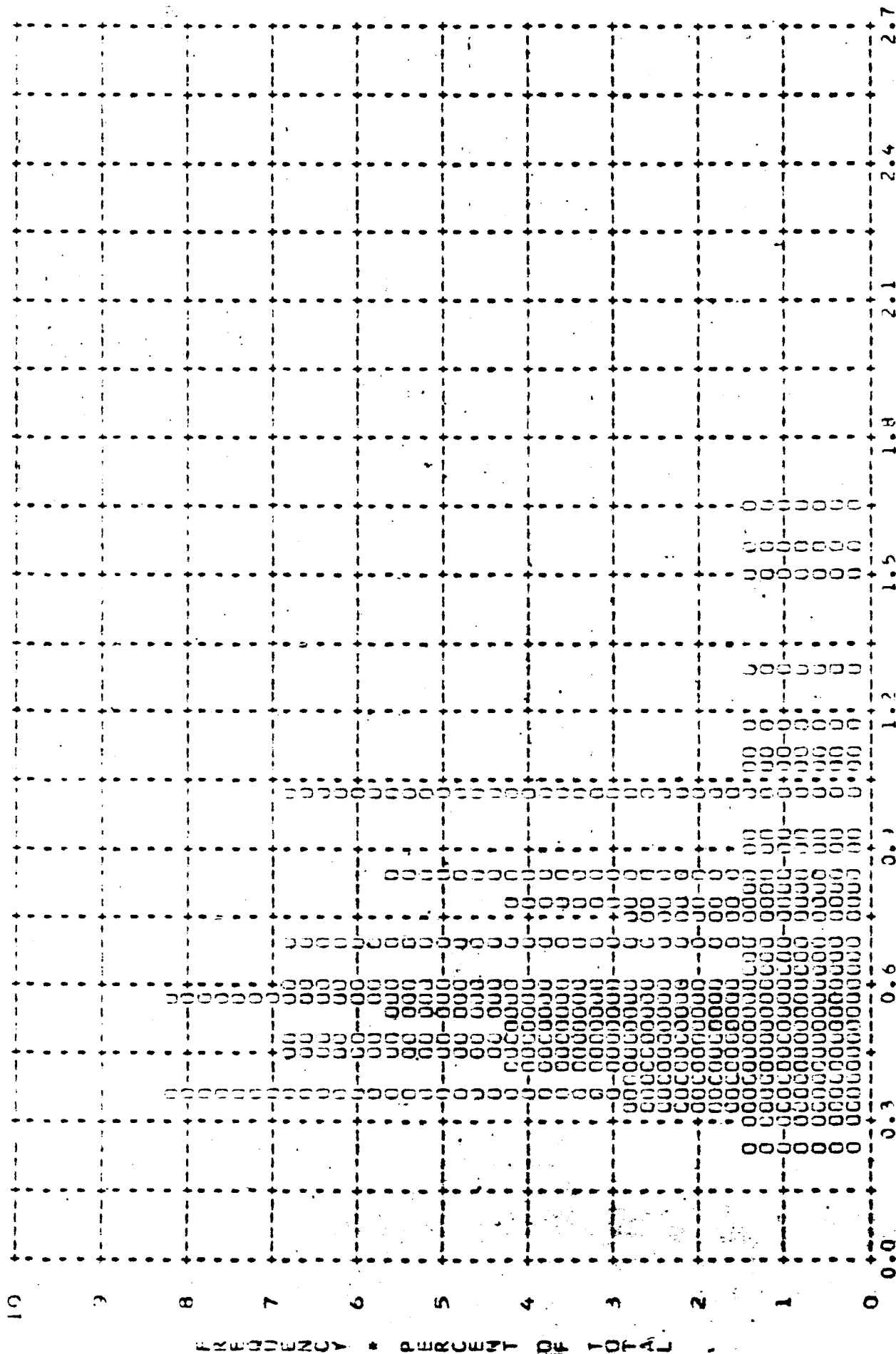

MISSION * 1030-2 * INSTR * FRMO * 5/25/56 PLOT OF G MAX * T-22A14 * PROCESSING * FULL
 ARITH MEAN * 1.07 * MEDIAN * 1.69 * STD DEV * 0.33 * RANGE * 2.37 TO 2.25 WITH 74 SAMPLES

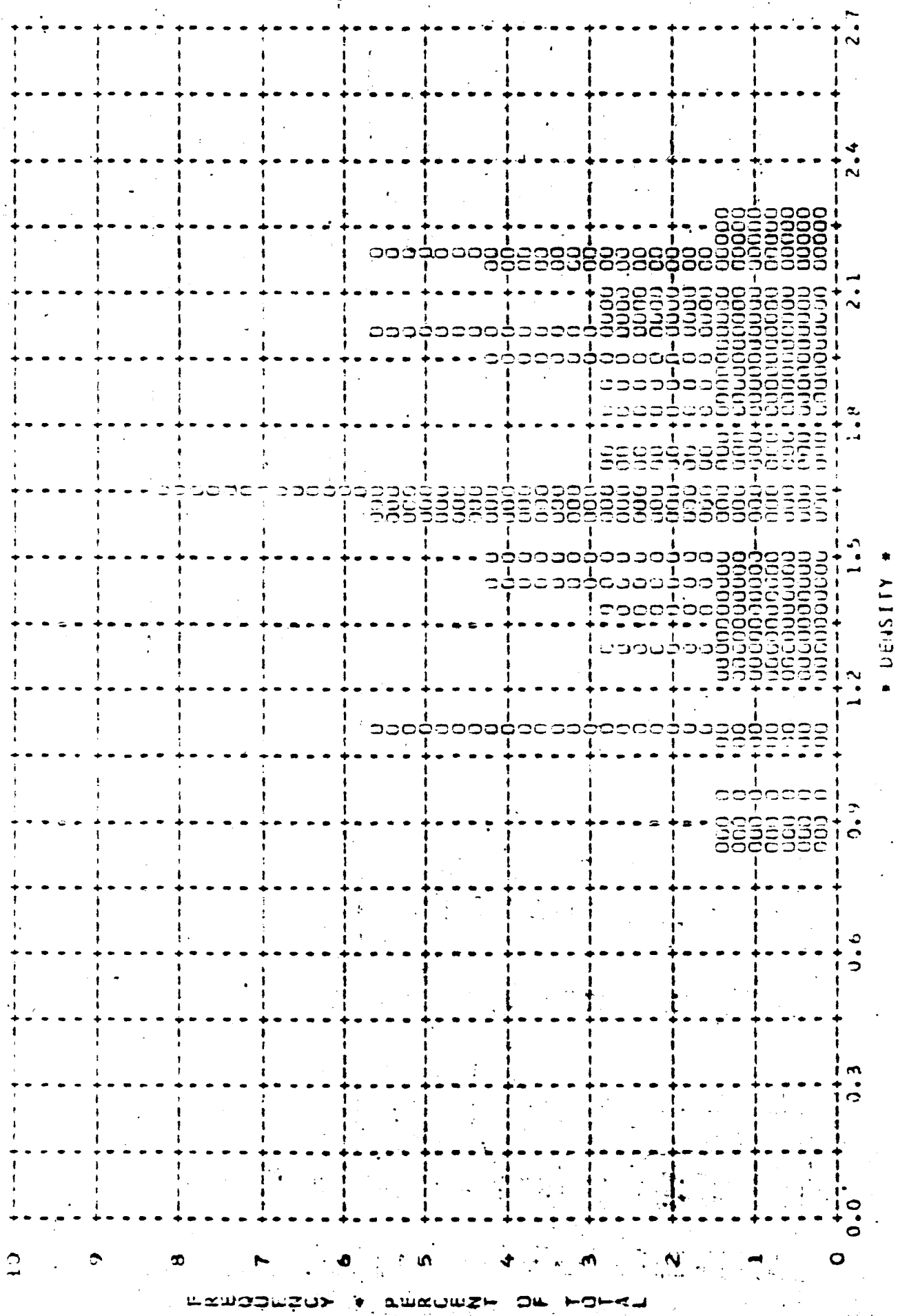

~~TOP SECRET~~

Figure A-26

[REDACTED]

MISSION * 1930-2 * I-51C * FWD * 725/16 PWT OF D MAX * C-100 * PROCESSING * FULL
ARITH MEAN * 2.39 * MEDIA * 2.15 * STD DEV * 0.21 * RANGE * 1.35 TO 2.35 WITH 60 SAMPLES

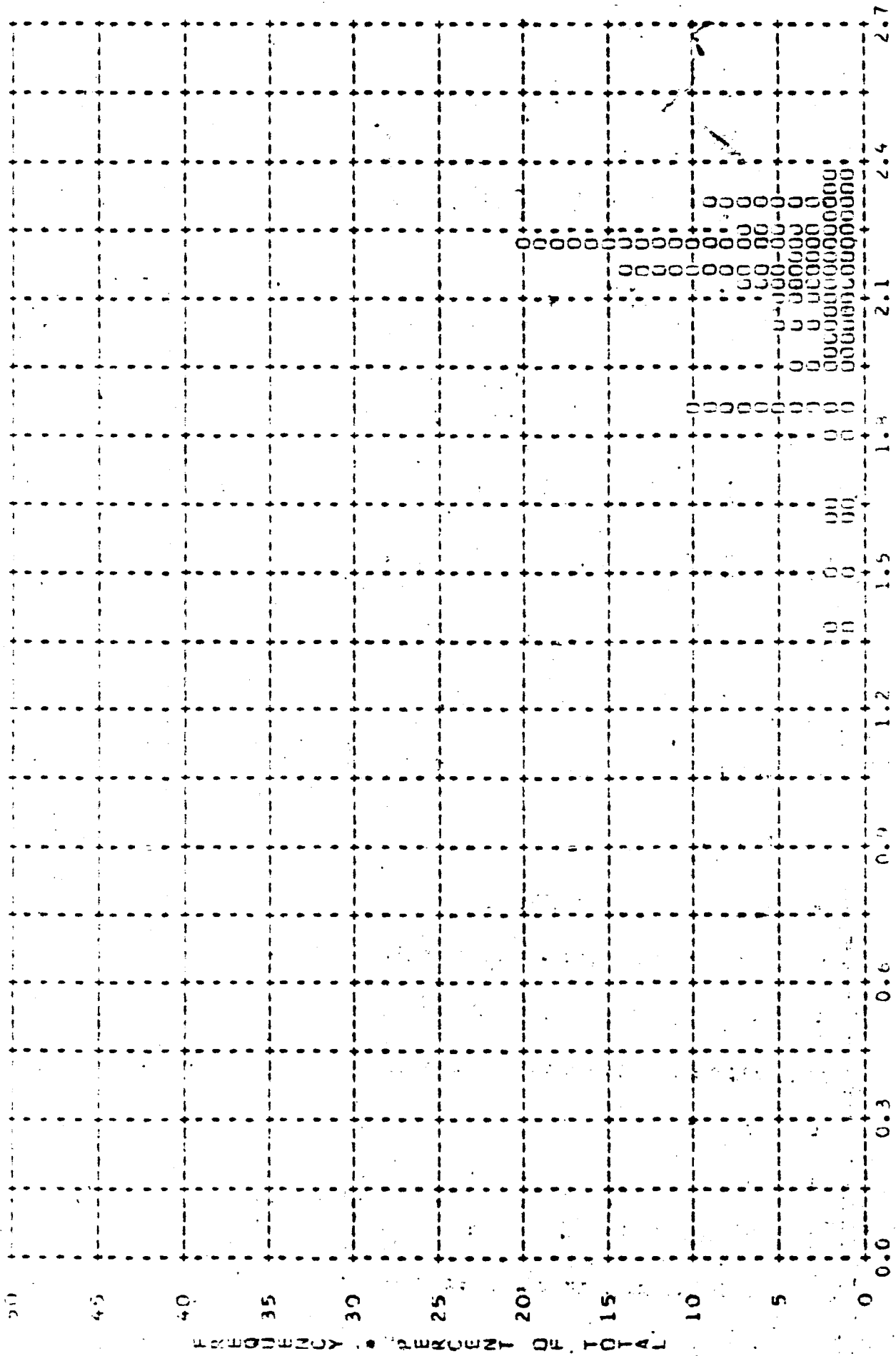

TOP SECRET

Figure A-27

MISSION * 1.300 * 1.110 * 1.100 * 0.950 * 0.900 * 0.850 * 0.800 * 0.750 * 0.700 * 0.650 * 0.600 * 0.550 * 0.500 * 0.450 * 0.400 * 0.350 * 0.300 * 0.250 * 0.200 * 0.150 * 0.100 * 0.050 * 0.000

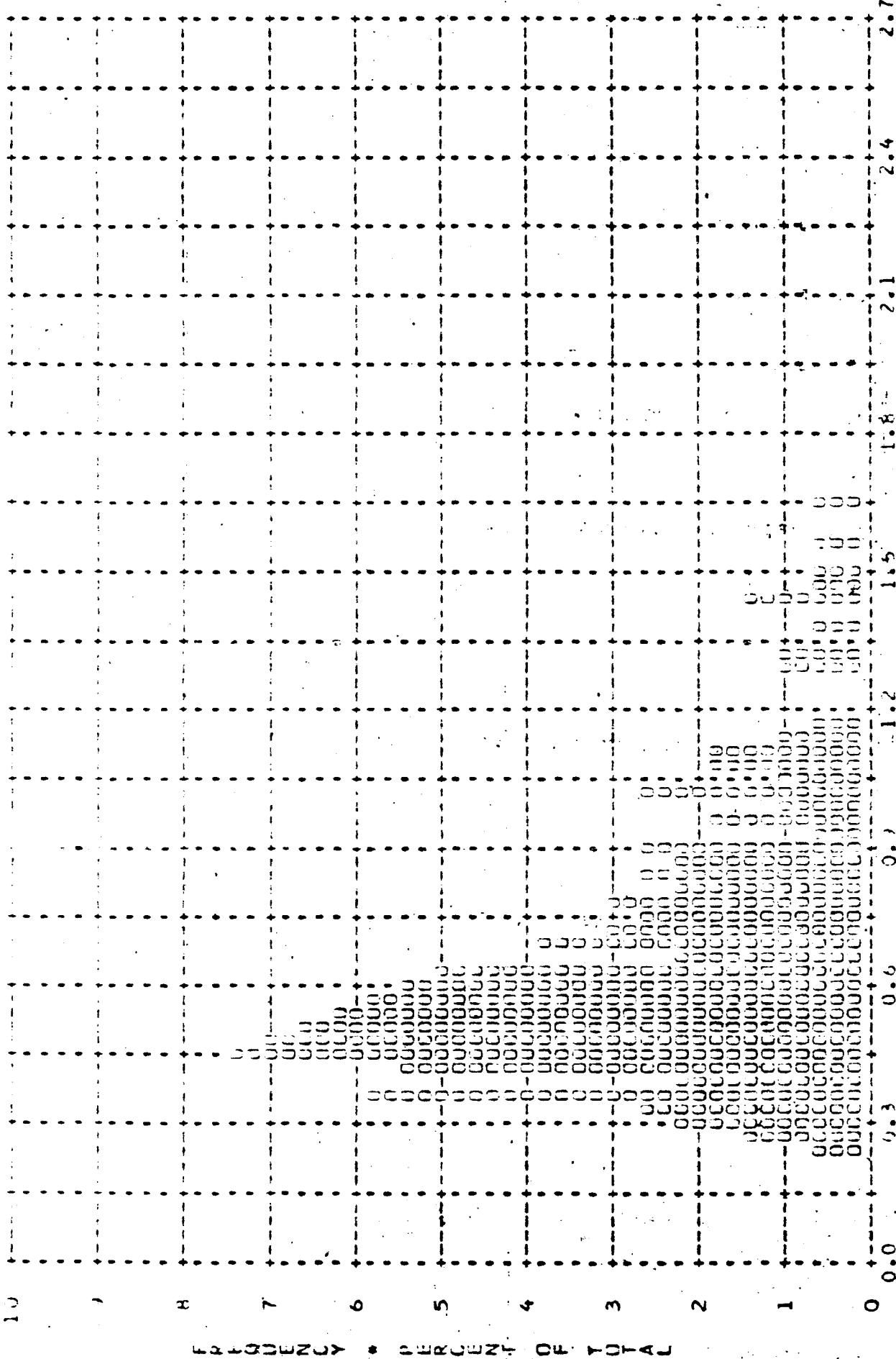

Figure A-28

~~TOP SECRET~~

MISSION * 10410 * LINE * FIVE * 072026 * TIME * D MAX * 1.3248 * PROCESSING * ALL LEVELS
ARITH MEAN * 1.00 * MULTIPLY * 1.00 * DIVIDE BY * 3.1 * PARAM * 1.76 * 2.26 WITH 246 SAMPLES

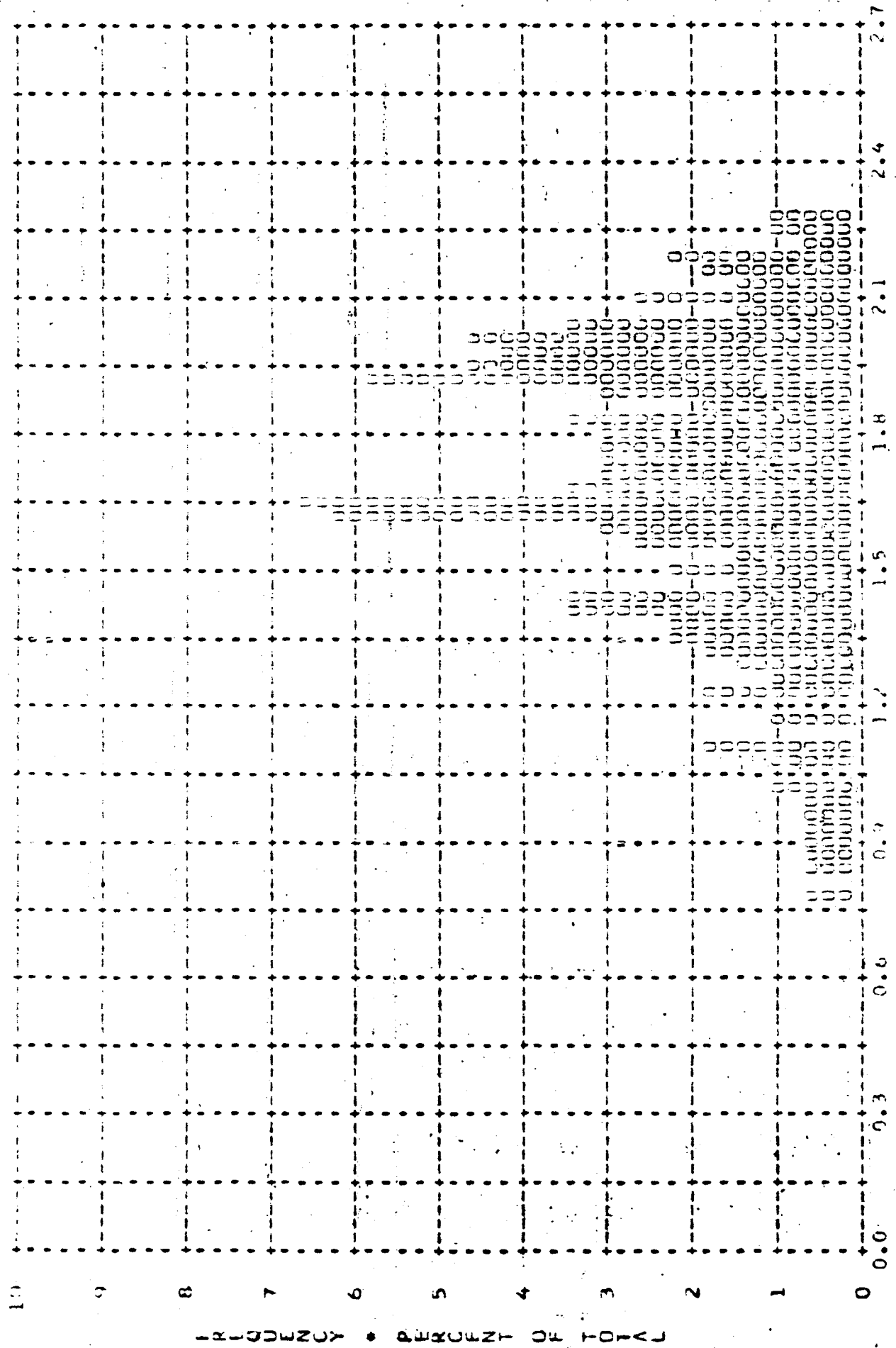

Figure A-29

~~TOP SECRET~~

MISSION * 10500 * 16.18 * 15.50 * 14.76 * 14.00 * 13.24 * RANGE * 1.17 * 10 * 2.34 * WITH 172 SAMPLES

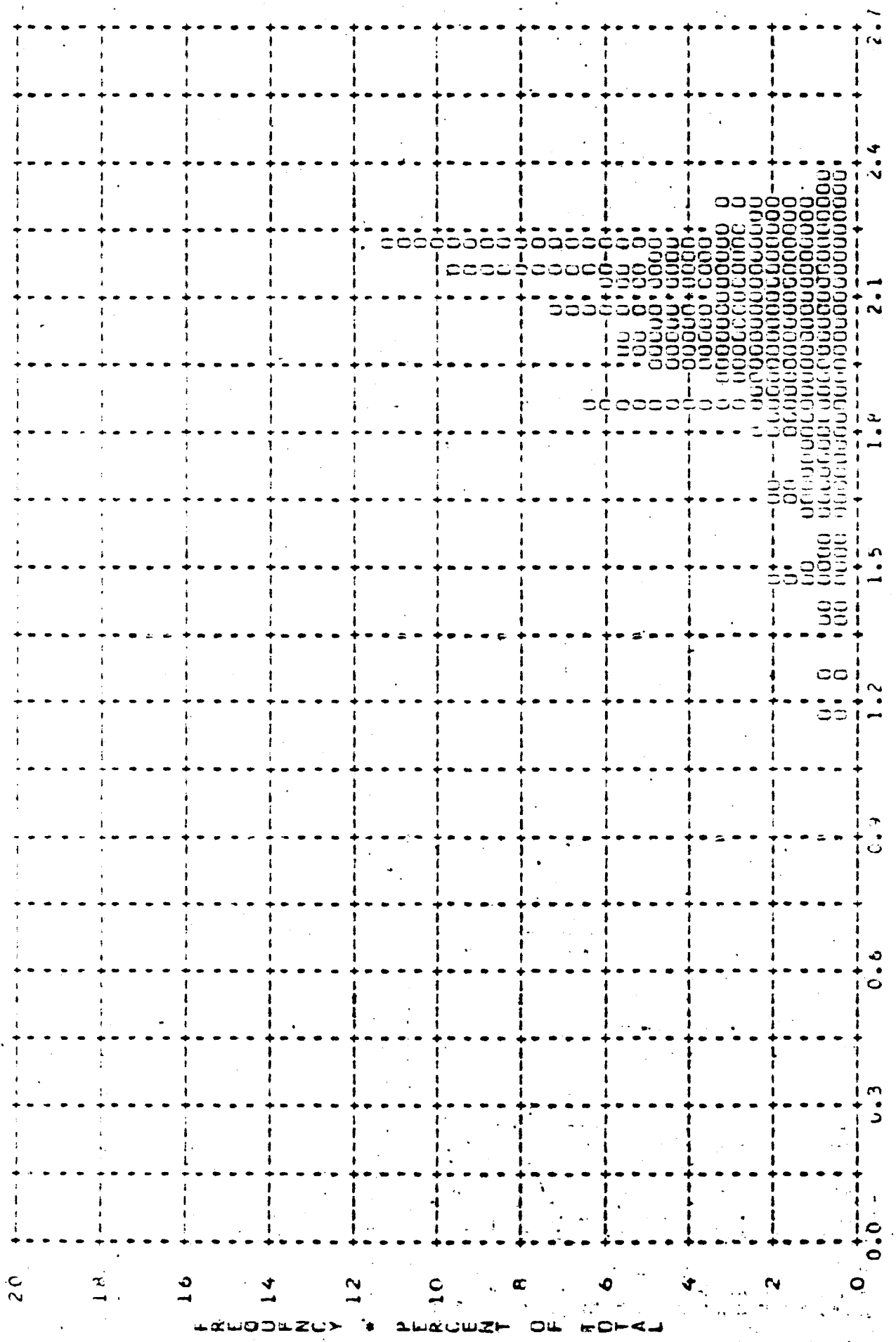

Figure A-30

TOP SECRET

DENSITY VALUE	PRIMARY		INTERMEDIATE			FULL			ALL LEVELS			
	MIN	MAX	LIM	MIN	MAX	LIM	MIN	MAX	LIM	MIN	MAX	LIM
0.01	0	0	0	0	0	0	0	0	0	0	0	0
0.02	0	0	0	0	0	0	0	0	0	0	0	0
0.03	0	0	0	0	0	0	0	0	0	0	0	0
0.04	0	0	0	0	0	0	0	0	0	0	0	0
0.05	0	0	0	0	0	0	0	0	0	0	0	0
0.06	0	0	0	0	0	0	0	0	0	0	0	0
0.07	0	0	0	0	0	0	0	0	0	0	0	0
0.08	0	0	0	0	0	0	0	0	0	0	0	0
0.09	0	0	0	0	0	0	0	0	0	0	0	0
0.10	0	0	0	0	0	0	0	0	0	0	0	0
0.11	0	0	0	0	0	0	0	0	0	0	0	0
0.12	0	0	0	0	0	0	0	0	0	0	0	0
0.13	0	0	0	0	0	0	0	0	0	0	0	0
0.14	0	0	0	0	0	0	0	0	0	0	0	0
0.15	0	0	0	0	0	0	0	0	0	0	0	0
0.16	0	0	0	0	0	0	0	0	0	0	0	0
0.17	0	0	0	0	0	0	0	0	0	0	0	0
0.18	0	0	0	0	0	0	0	0	0	0	0	0
0.19	0	0	0	0	0	0	0	0	0	0	0	0
0.20	0	0	0	0	0	0	0	0	0	0	0	0
0.21	0	0	0	0	0	0	0	0	0	0	0	0
0.22	0	0	0	0	0	0	0	0	0	0	0	0
0.23	0	0	0	0	0	0	0	0	0	0	0	0
0.24	0	0	0	0	0	0	0	0	0	0	0	0
0.25	0	0	0	0	0	0	0	0	0	0	0	0
0.26	0	0	0	0	0	0	0	0	0	0	0	0
0.27	0	0	0	0	0	0	0	0	0	0	0	0
0.28	0	0	0	0	0	0	0	0	0	0	0	0
0.29	0	0	0	0	0	0	0	0	0	0	0	0
0.30	0	0	0	0	0	0	0	0	0	0	0	0
0.31	0	0	0	0	0	0	0	0	0	0	0	0
0.32	0	0	0	0	0	0	0	0	0	0	0	0
0.33	0	0	0	0	0	0	0	0	0	0	0	0
0.34	0	0	0	0	0	0	0	0	0	0	0	0
0.35	0	0	0	0	0	0	0	0	0	0	0	0
0.36	0	0	0	0	0	0	0	0	0	0	0	0
0.37	0	0	0	0	0	0	0	0	0	0	0	0
0.38	0	0	0	0	0	0	0	0	0	0	0	0
0.39	0	0	0	0	0	0	0	0	0	0	0	0
0.40	0	0	0	0	0	0	0	0	0	0	0	0
0.41	0	0	0	0	0	0	0	0	0	0	0	0
0.42	0	0	0	0	0	0	0	0	0	0	0	0
0.43	0	0	0	0	0	0	0	0	0	0	0	0
0.44	0	0	0	0	0	0	0	0	0	0	0	0
0.45	0	0	0	0	0	0	0	0	0	0	0	0
0.46	0	0	0	0	0	0	0	0	0	0	0	0
0.47	0	0	0	0	0	0	0	0	0	0	0	0
0.48	0	0	0	0	0	0	0	0	0	0	0	0
0.49	0	0	0	0	0	0	0	0	0	0	0	0
0.50	0	0	0	0	0	0	0	0	0	0	0	0
0.51	0	0	0	0	0	0	0	0	0	0	0	0
0.52	0	0	0	0	0	0	0	0	0	0	0	0
0.53	0	0	0	0	0	0	0	0	0	0	0	0
0.54	0	0	0	0	0	0	0	0	0	0	0	0
0.55	0	0	0	0	0	0	0	0	0	0	0	0
0.56	0	0	0	0	0	0	0	0	0	0	0	0
0.57	0	0	0	0	0	0	0	0	0	0	0	0
0.58	0	0	0	0	0	0	0	0	0	0	0	0
0.59	0	0	0	0	0	0	0	0	0	0	0	0
0.60	0	0	0	0	0	0	0	0	0	0	0	0
0.61	0	0	0	0	0	0	0	0	0	0	0	0
0.62	0	0	0	0	0	0	0	0	0	0	0	0
0.63	0	0	0	0	0	0	0	0	0	0	0	0
0.64	0	0	0	0	0	0	0	0	0	0	0	0
0.65	0	0	0	0	0	0	0	0	0	0	0	0
0.66	0	0	0	0	0	0	0	0	0	0	0	0
0.67	0	0	0	0	0	0	0	0	0	0	0	0
0.68	0	0	0	0	0	0	0	0	0	0	0	0
0.69	0	0	0	0	0	0	0	0	0	0	0	0
0.70	0	0	0	0	0	0	0	0	0	0	0	0
0.71	0	0	0	0	0	0	0	0	0	0	0	0
0.72	0	0	0	0	0	0	0	0	0	0	0	0
0.73	0	0	0	0	0	0	0	0	0	0	0	0
0.74	0	0	0	0	0	0	0	0	0	0	0	0
0.75	0	0	0	0	0	0	0	0	0	0	0	0
0.76	0	0	0	0	0	0	0	0	0	0	0	0
0.77	0	0	0	0	0	0	0	0	0	0	0	0
0.78	0	0	0	0	0	0	0	0	0	0	0	0
0.79	0	0	0	0	0	0	0	0	0	0	0	0
0.80	0	0	0	0	0	0	0	0	0	0	0	0
0.81	0	0	0	0	0	0	0	0	0	0	0	0
0.82	0	0	0	0	0	0	0	0	0	0	0	0
0.83	0	0	0	0	0	0	0	0	0	0	0	0
0.84	0	0	0	0	0	0	0	0	0	0	0	0
0.85	0	0	0	0	0	0	0	0	0	0	0	0
0.86	0	0	0	0	0	0	0	0	0	0	0	0
0.87	0	0	0	0	0	0	0	0	0	0	0	0
0.88	0	0	0	0	0	0	0	0	0	0	0	0
0.89	0	0	0	0	0	0	0	0	0	0	0	0
0.90	0	0	0	0	0	0	0	0	0	0	0	0
0.91	0	0	0	0	0	0	0	0	0	0	0	0
0.92	0	0	0	0	0	0	0	0	0	0	0	0
0.93	0	0	0	0	0	0	0	0	0	0	0	0
0.94	0	0	0	0	0	0	0	0	0	0	0	0
0.95	0	0	0	0	0	0	0	0	0	0	0	0
0.96	0	0	0	0	0	0	0	0	0	0	0	0
0.97	0	0	0	0	0	0	0	0	0	0	0	0
0.98	0	0	0	0	0	0	0	0	0	0	0	0
0.99	0	0	0	0	0	0	0	0	0	0	0	0
1.00	0	0	0	0	0	0	0	0	0	0	0	0

Table A-4

DENSITY VALUE	PRIMARY			INTERMEDIATE			FULL			ALL LEVELS		
	MIN	MAX	LIM	MIN	MAX	LIM	MIN	MAX	LIM	MIN	MAX	LIM
0.51												
0.52												
0.53												
0.54												
0.55												
0.56												
0.57												
0.58												
0.59												
0.60												
0.61												
0.62												
0.63												
0.64												
0.65												
0.66												
0.67												
0.68												
0.69												
0.70												
0.71												
0.72												
0.73												
0.74												
0.75												
0.76												
0.77												
0.78												
0.79												
0.80												
0.81												
0.82												
0.83												
0.84												
0.85												
0.86												
0.87												
0.88												
0.89												
0.90												
0.91												
0.92												
0.93												
0.94												
0.95												
0.96												
0.97												
0.98												
0.99												
1.00												
SUBTOTAL												

Table A-4

DENSITY VALUE	PRIMARY			INTERMEDIATE			FULL			ALL LEVELS		
	MIN	MAX	LIM	MIN	MAX	LIM	MIN	MAX	LIM	MIN	MAX	LIM
1.01	0	0	0	1	0	0	1	0	0	2	0	0
1.02	0	0	0	1	0	0	1	0	0	2	0	0
1.03	0	0	0	1	0	0	1	0	0	2	0	0
1.04	0	0	0	1	0	0	1	0	0	2	0	0
1.05	0	0	0	1	0	0	1	0	0	2	0	0
1.06	0	0	0	1	0	0	1	0	0	2	0	0
1.07	0	0	0	1	0	0	1	0	0	2	0	0
1.08	0	0	0	1	0	0	1	0	0	2	0	0
1.09	0	0	0	1	0	0	1	0	0	2	0	0
1.10	0	0	0	1	0	0	1	0	0	2	0	0
1.11	0	0	0	1	0	0	1	0	0	2	0	0
1.12	0	0	0	1	0	0	1	0	0	2	0	0
1.13	0	0	0	1	0	0	1	0	0	2	0	0
1.14	0	0	0	1	0	0	1	0	0	2	0	0
1.15	0	0	0	1	0	0	1	0	0	2	0	0
1.16	0	0	0	1	0	0	1	0	0	2	0	0
1.17	0	0	0	1	0	0	1	0	0	2	0	0
1.18	0	0	0	1	0	0	1	0	0	2	0	0
1.19	0	0	0	1	0	0	1	0	0	2	0	0
1.20	0	0	0	1	0	0	1	0	0	2	0	0
1.21	0	0	0	1	0	0	1	0	0	2	0	0
1.22	0	0	0	1	0	0	1	0	0	2	0	0
1.23	0	0	0	1	0	0	1	0	0	2	0	0
1.24	0	0	0	1	0	0	1	0	0	2	0	0
1.25	0	0	0	1	0	0	1	0	0	2	0	0
1.26	0	0	0	1	0	0	1	0	0	2	0	0
1.27	0	0	0	1	0	0	1	0	0	2	0	0
1.28	0	0	0	1	0	0	1	0	0	2	0	0
1.29	0	0	0	1	0	0	1	0	0	2	0	0
1.30	0	0	0	1	0	0	1	0	0	2	0	0
1.31	0	0	0	1	0	0	1	0	0	2	0	0
1.32	0	0	0	1	0	0	1	0	0	2	0	0
1.33	0	0	0	1	0	0	1	0	0	2	0	0
1.34	0	0	0	1	0	0	1	0	0	2	0	0
1.35	0	0	0	1	0	0	1	0	0	2	0	0
1.36	0	0	0	1	0	0	1	0	0	2	0	0
1.37	0	0	0	1	0	0	1	0	0	2	0	0
1.38	0	0	0	1	0	0	1	0	0	2	0	0
1.39	0	0	0	1	0	0	1	0	0	2	0	0
1.40	0	0	0	1	0	0	1	0	0	2	0	0
1.41	0	0	0	1	0	0	1	0	0	2	0	0
1.42	0	0	0	1	0	0	1	0	0	2	0	0
1.43	0	0	0	1	0	0	1	0	0	2	0	0
1.44	0	0	0	1	0	0	1	0	0	2	0	0
1.45	0	0	0	1	0	0	1	0	0	2	0	0
1.46	0	0	0	1	0	0	1	0	0	2	0	0
1.47	0	0	0	1	0	0	1	0	0	2	0	0
1.48	0	0	0	1	0	0	1	0	0	2	0	0
1.49	0	0	0	1	0	0	1	0	0	2	0	0
1.50	0	0	0	1	0	0	1	0	0	2	0	0
1.51	0	0	0	1	0	0	1	0	0	2	0	0
1.52	0	0	0	1	0	0	1	0	0	2	0	0
1.53	0	0	0	1	0	0	1	0	0	2	0	0
1.54	0	0	0	1	0	0	1	0	0	2	0	0
1.55	0	0	0	1	0	0	1	0	0	2	0	0
1.56	0	0	0	1	0	0	1	0	0	2	0	0
1.57	0	0	0	1	0	0	1	0	0	2	0	0
1.58	0	0	0	1	0	0	1	0	0	2	0	0
1.59	0	0	0	1	0	0	1	0	0	2	0	0
1.60	0	0	0	1	0	0	1	0	0	2	0	0
1.61	0	0	0	1	0	0	1	0	0	2	0	0
1.62	0	0	0	1	0	0	1	0	0	2	0	0
1.63	0	0	0	1	0	0	1	0	0	2	0	0
1.64	0	0	0	1	0	0	1	0	0	2	0	0
1.65	0	0	0	1	0	0	1	0	0	2	0	0
1.66	0	0	0	1	0	0	1	0	0	2	0	0
1.67	0	0	0	1	0	0	1	0	0	2	0	0
1.68	0	0	0	1	0	0	1	0	0	2	0	0
1.69	0	0	0	1	0	0	1	0	0	2	0	0
1.70	0	0	0	1	0	0	1	0	0	2	0	0
1.71	0	0	0	1	0	0	1	0	0	2	0	0
1.72	0	0	0	1	0	0	1	0	0	2	0	0
1.73	0	0	0	1	0	0	1	0	0	2	0	0
1.74	0	0	0	1	0	0	1	0	0	2	0	0
1.75	0	0	0	1	0	0	1	0	0	2	0	0
1.76	0	0	0	1	0	0	1	0	0	2	0	0
1.77	0	0	0	1	0	0	1	0	0	2	0	0
1.78	0	0	0	1	0	0	1	0	0	2	0	0
1.79	0	0	0	1	0	0	1	0	0	2	0	0
1.80	0	0	0	1	0	0	1	0	0	2	0	0
1.81	0	0	0	1	0	0	1	0	0	2	0	0
1.82	0	0	0	1	0	0	1	0	0	2	0	0
1.83	0	0	0	1	0	0	1	0	0	2	0	0
1.84	0	0	0	1	0	0	1	0	0	2	0	0
1.85	0	0	0	1	0	0	1	0	0	2	0	0
1.86	0	0	0	1	0	0	1	0	0	2	0	0
1.87	0	0	0	1	0	0	1	0	0	2	0	0
1.88	0	0	0	1	0	0	1	0	0	2	0	0
1.89	0	0	0	1	0	0	1	0	0	2	0	0
1.90	0	0	0	1	0	0	1	0	0	2	0	0
1.91	0	0	0	1	0	0	1	0	0	2	0	0
1.92	0	0	0	1	0	0	1	0	0	2	0	0
1.93	0	0	0	1	0	0	1	0	0	2	0	0
1.94	0	0	0	1	0	0	1	0	0	2	0	0
1.95	0	0	0	1	0	0	1	0	0	2	0	0
1.96	0	0	0	1	0	0	1	0	0	2	0	0
1.97	0	0	0	1	0	0	1	0	0	2	0	0
1.98	0	0	0	1	0	0	1	0	0	2	0	0
1.99	0	0	0	1	0	0	1	0	0	2	0	0
2.00	0	0	0	1	0	0	1	0	0	2	0	0

SECRET

Table A-4

DENSITY VALUE	PRIMARY		INTERMEDIATE			FULL			ALL LEVELS			
	MIN	MAX	LIM	MIN	MAX	LIM	MIN	MAX	LIM	MIN	MAX	LIM
1.00												
1.01												
1.02												
1.03												
1.04												
1.05												
1.06												
1.07												
1.08												
1.09												
1.10												
1.11												
1.12												
1.13												
1.14												
1.15												
1.16												
1.17												
1.18												
1.19												
1.20												
1.21												
1.22												
1.23												
1.24												
1.25												
1.26												
1.27												
1.28												
1.29												
1.30												
1.31												
1.32												
1.33												
1.34												
1.35												
1.36												
1.37												
1.38												
1.39												
1.40												
1.41												
1.42												
1.43												
1.44												
1.45												
1.46												
1.47												
1.48												
1.49												
1.50												
1.51												
1.52												
1.53												
1.54												
1.55												
1.56												
1.57												
1.58												
1.59												
1.60												
1.61												
1.62												
1.63												
1.64												
1.65												
1.66												
1.67												
1.68												
1.69												
1.70												
1.71												
1.72												
1.73												
1.74												
1.75												
1.76												
1.77												
1.78												
1.79												
1.80												
1.81												
1.82												
1.83												
1.84												
1.85												
1.86												
1.87												
1.88												
1.89												
1.90												
1.91												
1.92												
1.93												
1.94												
1.95												
1.96												
1.97												
1.98												
1.99												
2.00												
SUBTOTAL												

Table A-4

MISSION * 1030-2 * INSTRUMENT * AFT 3/25/66 DENSITY FREQ CISTR

DENSITY VALUE	PRIMARY		INTERMEDIATE			FULL			ALL LEVELS			
	MIN	MAX	LIM	MIN	MAX	LIM	MIN	MAX	LIM	MIN	MAX	LIM
2.01												
2.02												
2.03												
2.04												
2.05												
2.06												
2.07												
2.08												
2.09												
2.10												
2.11												
2.12												
2.13												
2.14												
2.15												
2.17												
2.18												
2.19												
2.20												
2.21												
2.22												
2.23												
2.24												
2.25												
2.26												
2.27												
2.28												
2.29												
2.30												
2.31												
2.32												
2.33												
2.34												
2.35												
2.36												
2.37												
2.38												
2.39												
2.40												
2.41												
2.42												
2.43												
2.44												
2.45												
2.46												
2.47												
2.48												
2.49												
2.50												
SUM TOTAL												

Table A-4

MISSION • 1030-2 • INSTRUMENT • AFT 8/25/66 DENSITY FREQ DISTR

DENSITY VALUE	PRIMARY		INTERMEDIATE			FULL			ALL LEVELS			
	MIN	MAX LIM	MIN	MAX	LIM	MIN	MAX	LIM	MIN	MAX	LIM	
2.01	0	0	0	0	0	0	0	0	0	0	0	
2.02	0	0	0	0	0	0	0	0	0	0	0	
2.03	0	0	0	0	0	0	0	0	0	0	0	
2.04	0	0	0	0	0	0	0	0	0	0	0	
2.05	0	0	0	0	0	0	0	0	0	0	0	
2.06	0	0	0	0	0	0	0	0	0	0	0	
2.07	0	0	0	0	0	0	0	0	0	0	0	
2.08	0	0	0	0	0	0	0	0	0	0	0	
2.09	0	0	0	0	0	0	0	0	0	0	0	
2.10	0	0	0	0	0	0	0	0	0	0	0	
2.11	0	0	0	0	0	0	0	0	0	0	0	
2.12	0	0	0	0	0	0	0	0	0	0	0	
2.13	0	0	0	0	0	0	0	0	0	0	0	
2.14	0	0	0	0	0	0	0	0	0	0	0	
2.15	0	0	0	0	0	0	0	0	0	0	0	
2.16	0	0	0	0	0	0	0	0	0	0	0	
2.17	0	0	0	0	0	0	0	0	0	0	0	
2.18	0	0	0	0	0	0	0	0	0	0	0	
2.19	0	0	0	0	0	0	0	0	0	0	0	
2.20	0	0	0	0	0	0	0	0	0	0	0	
2.21	0	0	0	0	0	0	0	0	0	0	0	
2.22	0	0	0	0	0	0	0	0	0	0	0	
2.23	0	0	0	0	0	0	0	0	0	0	0	
2.24	0	0	0	0	0	0	0	0	0	0	0	
2.25	0	0	0	0	0	0	0	0	0	0	0	
2.26	0	0	0	0	0	0	0	0	0	0	0	
2.27	0	0	0	0	0	0	0	0	0	0	0	
2.28	0	0	0	0	0	0	0	0	0	0	0	
2.29	0	0	0	0	0	0	0	0	0	0	0	
2.30	0	0	0	0	0	0	0	0	0	0	0	
2.31	0	0	0	0	0	0	0	0	0	0	0	
2.32	0	0	0	0	0	0	0	0	0	0	0	
2.33	0	0	0	0	0	0	0	0	0	0	0	
2.34	0	0	0	0	0	0	0	0	0	0	0	
2.35	0	0	0	0	0	0	0	0	0	0	0	
2.36	0	0	0	0	0	0	0	0	0	0	0	
2.37	0	0	0	0	0	0	0	0	0	0	0	
2.38	0	0	0	0	0	0	0	0	0	0	0	
2.39	0	0	0	0	0	0	0	0	0	0	0	
2.40	0	0	0	0	0	0	0	0	0	0	0	
2.41	0	0	0	0	0	0	0	0	0	0	0	
2.42	0	0	0	0	0	0	0	0	0	0	0	
2.43	0	0	0	0	0	0	0	0	0	0	0	
2.44	0	0	0	0	0	0	0	0	0	0	0	
2.45	0	0	0	0	0	0	0	0	0	0	0	
2.46	0	0	0	0	0	0	0	0	0	0	0	
2.47	0	0	0	0	0	0	0	0	0	0	0	
2.48	0	0	0	0	0	0	0	0	0	0	0	
2.49	0	0	0	0	0	0	0	0	0	0	0	
2.50	0	0	0	0	0	0	0	0	0	0	0	
SUBTOTAL	0	0	0	0	0	0	0	0	0	0	0	
TOTAL	0	0	0	73	72	56	171	171	104	244	244	160

MISSION 1030-2 INSTR - AFT 8/25/66 PROCESSING AND EXPOSURE ANALYSIS

PROCESS LEVEL	SAMPLE SIZE	UNDER EXPOSED	UNDER PROCESSED	CORRECT EXP+PROC	OVER PROCESSED	OVER EXPOSED
PRIMARY	0	0 PC	0 PC	0 PC	0 PC	0 PC
INTERMEDIATE	73	0 PC	1 PC	75 PC	19 PC	4 PC
FULL	171	2 PC	0 PC	63 PC	35 PC	1 PC
ALL LEVELS	244	2 PC	0 PC	66 PC	30 PC	2 PC

PROCESS LEVEL	RANGE + PC	UNDER EXPOSED	UNDER PROCESSED	CORRECT EXP+PROC	OVER PROCESSED	OVER EXPOSED
PRIMARY	0.01-0.09	0.01-0.13	0.14-0.39	0.40-0.90	-----	0.91 AND UP
INTERMED	0.10-0.17	0.01-0.20	0.21-0.39	0.40-0.90	0.91-1.34	1.35 AND UP
FULL	0.18 AND UP	0.01-0.39	-----	0.40-0.90	0.91-1.69	1.70 AND UP

Table A-4

MISSION * 1330-2 * LAWR * MET * 5/25/66 REPT OF D. IM * EX-RATE * PROCESSING * INTERMEDIATE
 METAL MEAN * 0.77 * METAL * 0.73 * STD DEV * 0.26 * RANGE * 0.34 TO 1.53 WITH 73 SAMPLES

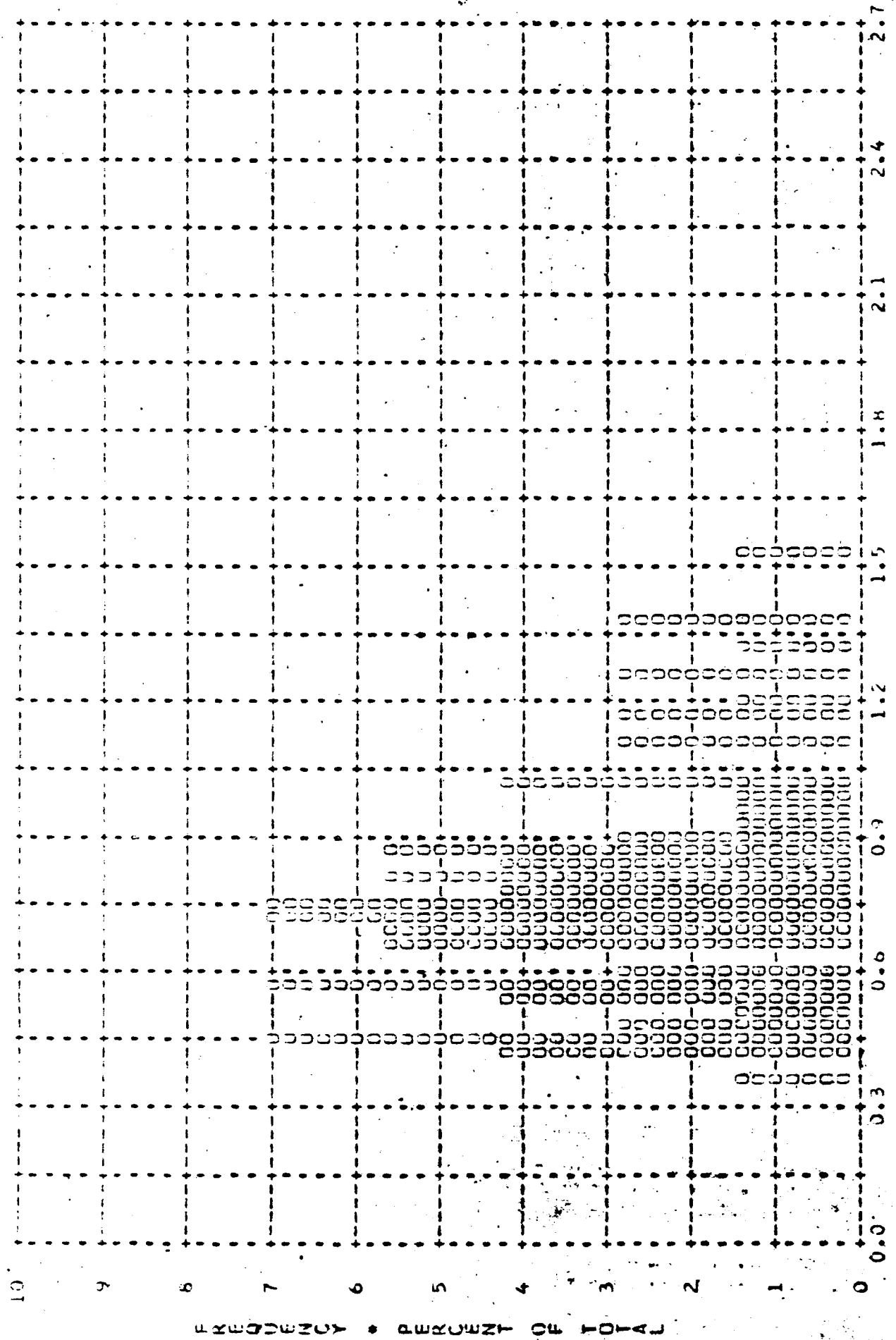

* DENSITY *

TOP SECRET

Figure A-31

MISSION * 1030-7 * INSTR * AFF * 8725726 PILOT OF D MAX * TERRAIN * PROCESSING * INTERMEDIATE
 ARITH MPAL * 1.79 * MEDIAN * 1.84 * STD DEV * 0.27 * RANGE * 0.83 TO 2.20 WITH 73 SAMPLES

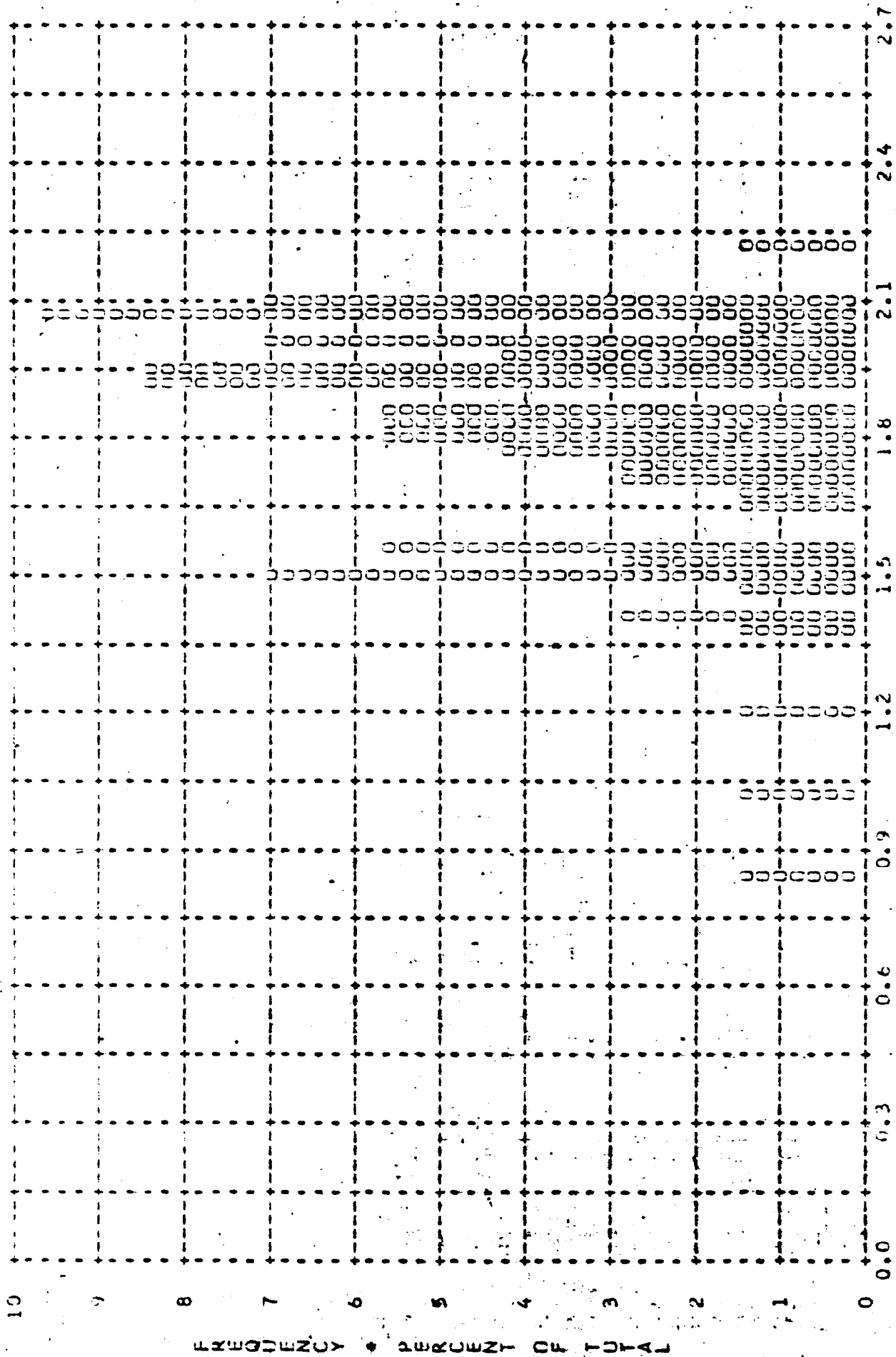

[REDACTED]

MISSION * 1030-2 * INJURY * AT * 9/25/66 FLUORIDE * FAX * 1000 * PROCESSING * INTERMEDIATE
ARITH MEAN * 2.65 * MULTIPLY * 2.95 * SQUARED * 0.17 * RANGE * 1.24 TO 2.34 WITH 56 SAMPLES

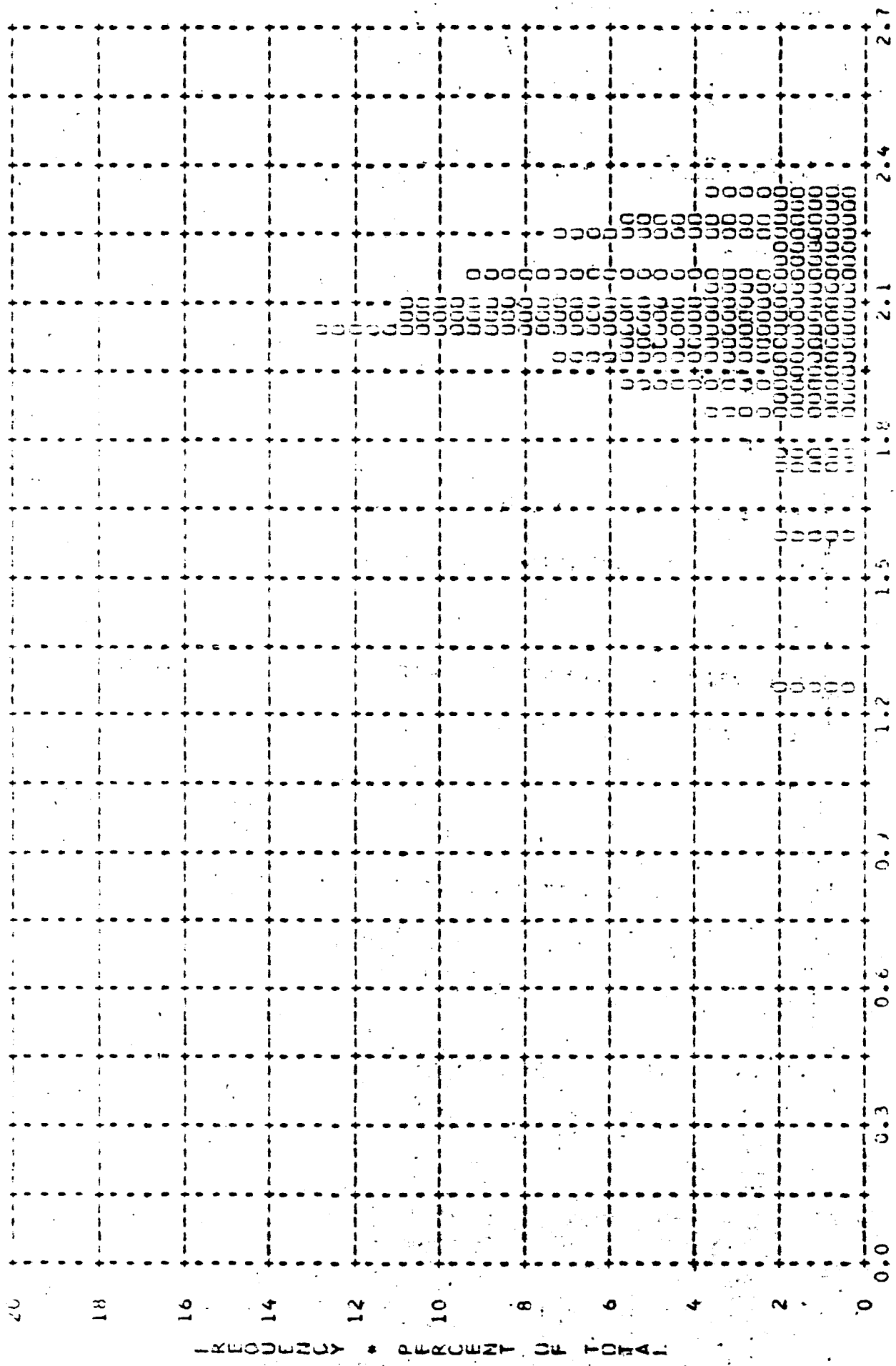

~~TOP SECRET~~

[REDACTED]

Figure A-38

MISSION * 1030-2 * JANR * AF1 * 7/25/66 PLOT OF D PIN * FREQUENCY * PROCESSING * FULL
 ARITH MEAN * 0.4 * MILLIA * 0.00 * SID DEV * 0.30 * RANGE * 0.30 TO 1.24 WITH 171 SAMPLES

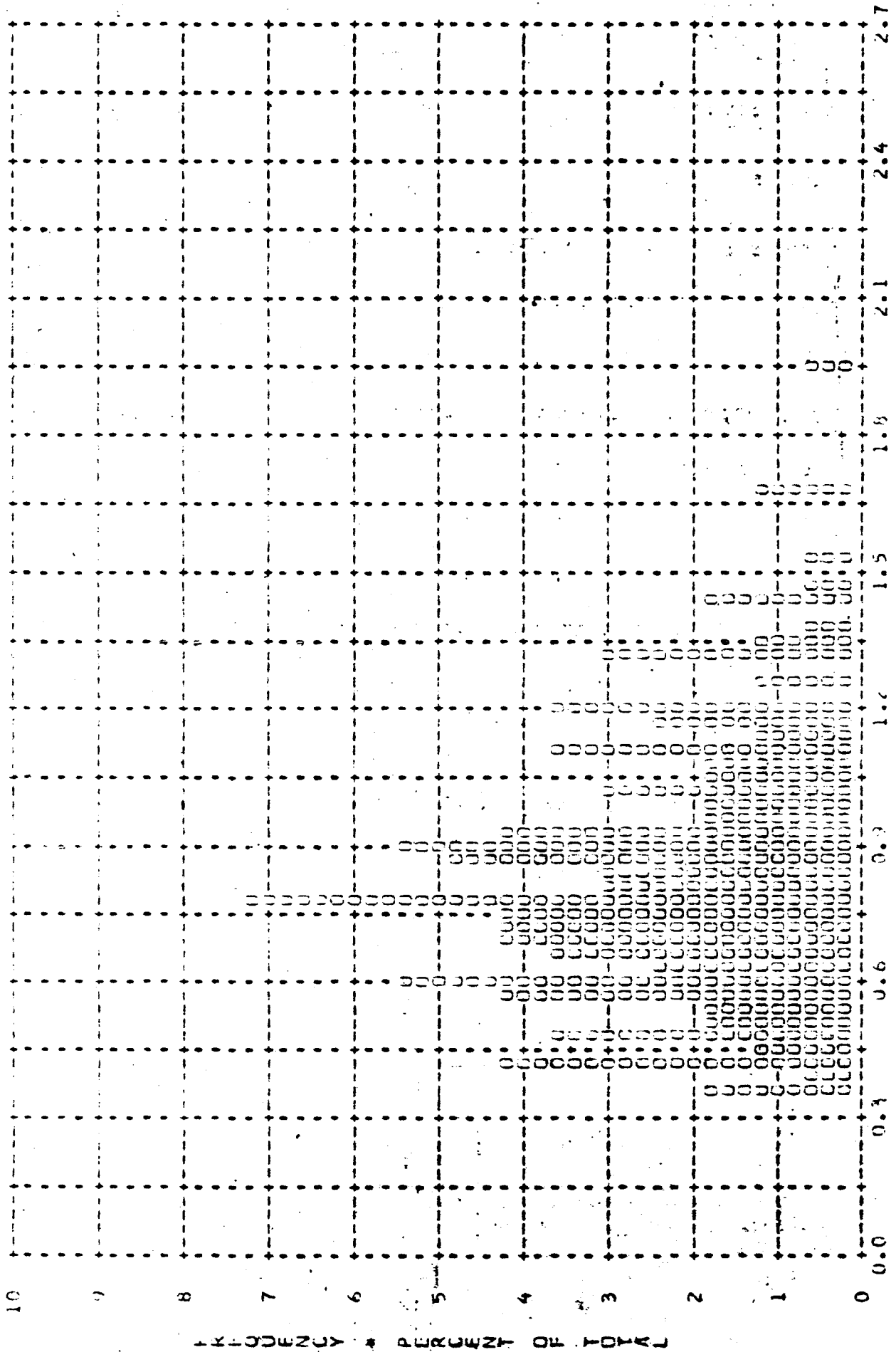

TOP SECRET

[REDACTED]

MISSION * 1030-2 * LOGIC * SET * 0/25/26 PLOT OF D MAX * TERRAIN * PROCESSING * FULL
ARITH MEAN * 1.58 * MEAN * 1.80 * STD DEV * 0.33 * RANGE * 0.70 TO 2.60 WITH 171 SAMPLES

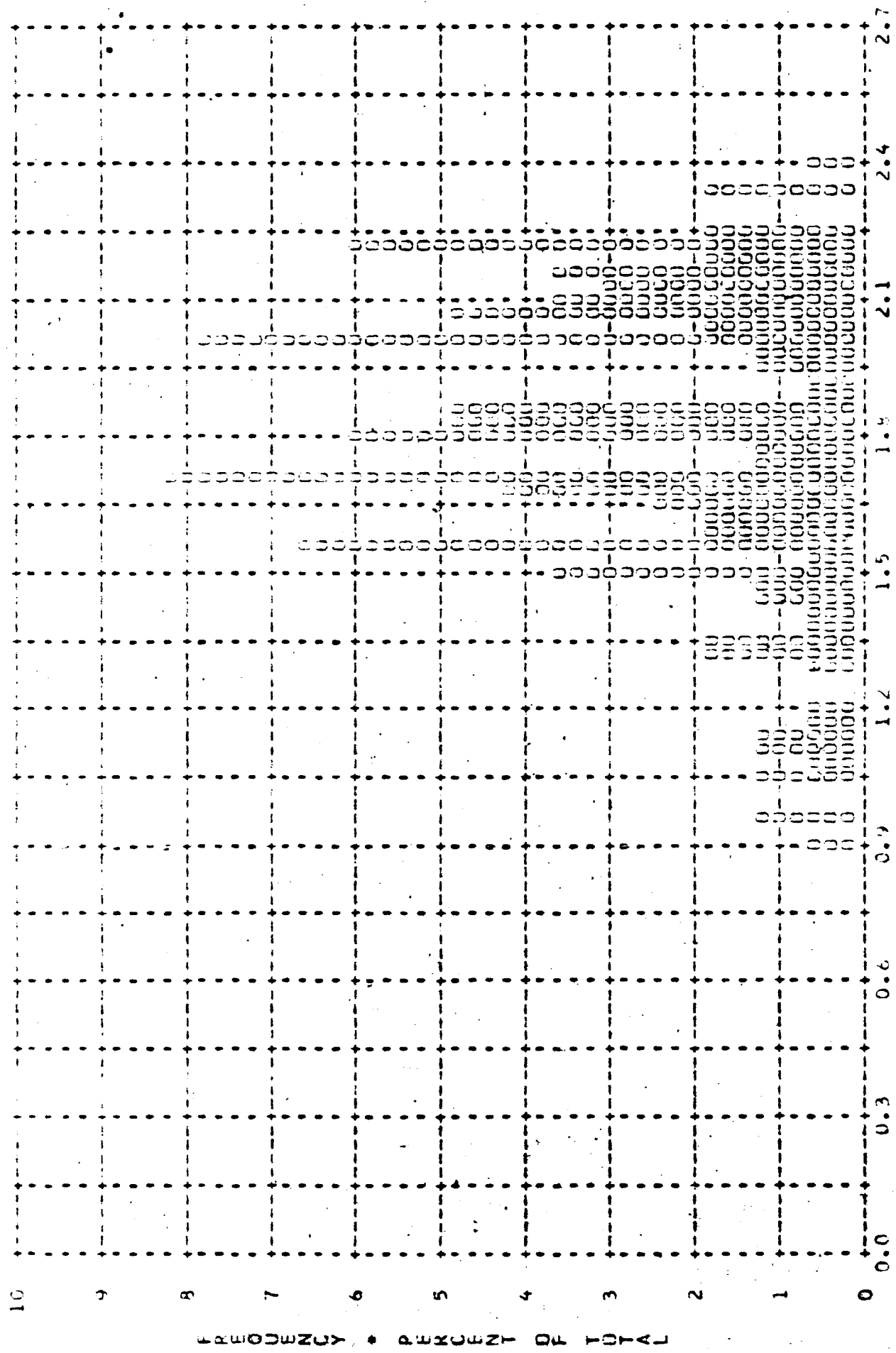

[REDACTED]

TOP SECRET

Figure A-35

MISSION • 1039 • PLOTTER • APT • 707 • G. PILOT • MAX • CLOUD • PROCESSING • FULL
 ARITH • AD • 2.07 • MULTIPLY • 2.16 • SUBTRACT • 0.51 • PAUSE • 0.03 TO 2.43 WITH 104 SAMPLES

FREQUENCY	PERCENT	OF TOTAL	DENSITY
10			
9			
8			
7			
6			
5			
4			
3			
2			
1			
0			

Figure A-36

MISSION * 1030-2 * TEST * SET * 172 7.6 * PLATE OF D MAX * 1.2441 * PROCESSING * ALL LEVELS
 ARITH MEAN * 1.79 * MEDIA * 1.63 * 1.11 LEV * 1.31 * RANGE * 0.01 TO 1.40 WITH 244 SAMPLES

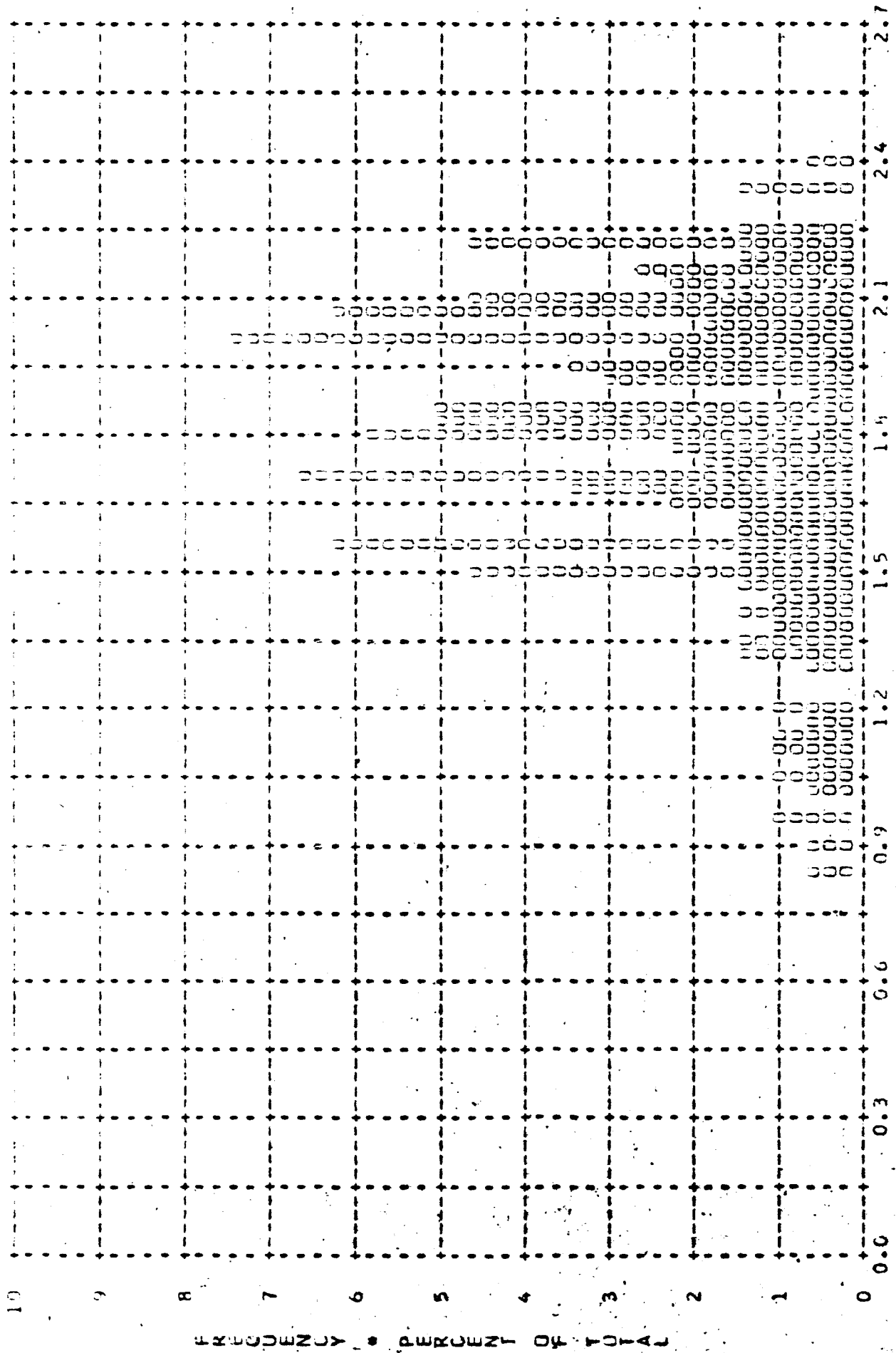

Figure A-38

TOP SECRET

MISSING * 103000 * IN JS * 0.01 * 0.7/0.6 PLOT OF 0. MAX * 0.001 * PROCESSING * ALL LEVELS
 WITH MEAN * 2.00 * MEDIAN * 2.10 * STD DEV * 0.7 * RATIO * 0.03 * 2.45 WITH 160 SAMPLES

	0.0	0.3	0.6	0.9	1.2	1.5	1.8	2.1	2.4	2.7
10										
9										
8										
7										
6										
5										
4										
3										
2										
1										
0										
FREQUENCY										
PERCENT										
OF TOTAL										
DENSITY										

Figure A-39

~~TOP SECRET C~~ [REDACTED]

Distribution:

Copy No.

To

[REDACTED]

[REDACTED]

~~TOP SECRET C~~ [REDACTED]